



Networking and  
Communications

# Service Guide

November 1992

No portion of this document may be produced in any form without the written permission of Apple Computer, Inc.

©1992 Apple Computer, Inc. Apple, the Apple logo, Apple IIgs, AppleLink, AppleShare, AppleTalk, A/UX, EtherTalk, ImageWriter, Inter•Poll, LaserWriter, LocalTalk, Macintosh, MacPAD, MacTCP, MacTerminal, and TokenTalk are trademarks of Apple Computer, Inc., registered in the U.S. and other countries. AppleFax, A/ROSE, Balloon Help, Disk First Aid, Mac ISDN, MacX25, Macintosh Quadra, PowerBook, SNA•ps, and System 7 are trademarks of Apple Computer, Inc.

MS-DOS is a registered trademark of Microsoft Corporation. NuBus is a trademark of Texas Instruments. PhoneNET is a registered trademark of Farallon Computing, Inc. UNIX is a registered trademark of UNIX System Laboratories.



**POSTSCRIPT**  
Software From Adobe

is a trademark of Adobe Systems Incorporated.

---

## Table of Contents

### General Information

AppleTalk Overview .....	2
AppleTalk Phase 2 Features .....	3
Extended Addressing .....	4
Dynamic Node Addressing .....	4
Distributed Name Service .....	4
AppleTalk Zones .....	4
Best Routing Algorithm .....	5
Upgrading to AppleTalk Phase 2 .....	5
AppleTalk Phase 2 in an Internet Environment .....	6
AppleTalk Network Tips .....	6
Network Topologies .....	7
Bus Topology .....	7
Star Topology .....	8
Ring Topology .....	8
Backbone Topology .....	9
Network Access Methods .....	10
CSMA .....	10
CSMA/CD .....	10
CSMA/CA .....	10
Token Passing .....	10
Transmission Media .....	11
Twisted-Pair .....	11
Coaxial Cable .....	12
Fiber-Optic .....	12
Infrared Media .....	12
Radio Frequency .....	12
Network Usage Planning .....	13
Network Services .....	14
Print Services .....	14
Shared Printing .....	14
Printing with a Server .....	15
File Services .....	15
Electronic Mail Services .....	16
Remote Dial-In Services .....	16

### Network Types

LocalTalk Networks .....	18
Comparing LocalTalk Transmission Media .....	19
Apple LocalTalk Cable System .....	20

---

Setting Up or Adding to the Network .....	21
Connecting Nodes .....	22
Adding a Device to the End of a Bus Network.....	22
Adding a Device Between Connector Boxes .....	23
Checking PhoneNET/LocalTalk Connections .....	24
Disconnecting Nodes .....	24
Symptom/Cure Chart for LocalTalk Networks.....	25
EtherTalk Networks.....	27
Comparing EtherTalk Transmission Media .....	29
Apple Ethernet Cable System .....	30
Setting Up or Adding to the Network .....	30
Using Thick Coax Cable .....	31
Using the Apple Ethernet Thin Coax Transceiver....	31
Using Thick Coax Cable .....	32
Using Twisted-Pair Cable and Apple Transceivers ..	32
Using Fiber-Optic Cable .....	33
Starting Up an EtherTalk Network .....	33
Symptom/Cure Chart for EtherTalk Networks.....	33
TokenTalk Networks.....	36
Comparing TokenTalk Transmission Media .....	37
Starting Up a TokenTalk Network.....	37
Multistation Access Unit (MAU).....	37
Symptom/Cure Chart for TokenTalk Networks.....	38
Expanded Networks.....	39
Repeaters .....	39
Bridges .....	39
Internet Networks.....	40
Routers .....	40
Gateways .....	41
Backbone Networks.....	41
Starting Up an Internet Network .....	42
Symptom/Cure Chart for Internet Networks.....	43
Networking Possibilities.....	44
General Network Tips.....	46
Tips for Setting Up an AppleTalk Network .....	46
Tips for Maintaining an AppleTalk Network .....	46

## **Apple Networking Hardware**

Interface Cards.....	50
Apple II Workstation Card.....	50
LocalTalk PC Card.....	50
Apple EtherTalk Interface and EtherTalk NB Cards.....	52

---

Apple Ethernet NB Card .....	54
Apple Ethernet LC Card .....	54
Apple Serial NB Card .....	56
Apple Coax/Twinax Card .....	57
Apple TokenTalk NB Card .....	58
Apple Token Ring 4/16 NB Card .....	59
Apple ISDN NB Card .....	60
ImageWriter II/LQ LocalTalk Option Card .....	61
Troubleshooting Interface Cards .....	62
Apple II Workstation Card .....	62
LocalTalk PC Card .....	62
EtherTalk Interface and EtherTalk NB Cards .....	62
Apple Ethernet NB Card .....	63
Apple Ethernet LC Card .....	63
Apple Serial NB Card .....	64
Apple Coax/Twinax Card .....	64
Apple Token Ring 4/16 NB Card .....	65
Apple TokenTalk NB Card .....	65
Apple ISDN NB Card .....	66
ImageWriter II/LQ LocalTalk Option Card .....	66
Interface Card Connectors and Cables .....	67
Apple LocalTalk Cable System .....	68
Apple Ethernet Cable System .....	71
Apple Ethernet Thin Coax Transceiver .....	71
Apple Ethernet Twisted-Pair Transceiver .....	72
Apple Ethernet AUI Adapter .....	73
Apple Ethernet Cable System Specifications .....	74
Modems .....	76
Apple Modem 300/1200 .....	76
Apple Personal Modem .....	77
Apple Data Modem 2400 .....	77
AppleFax Modem .....	78
Macintosh Portable Data Modem 2400 and Int'l XP 2400 Modem .....	79
Macintosh PowerBook Fax/Data Modem .....	79
Troubleshooting Modems .....	80
Power Test .....	80
Apple Modem 300/1200 .....	80
Personal Modem .....	80
Data Modem 2400 .....	81
AppleFax Modem .....	81

---

Phone Test .....	82
Personal Modem, Data Modem 2400, and AppleFAX Modem .....	82
Macintosh Portable and PowerBook Modems .....	82
Computer Test .....	84
Modem Specifications .....	85
Pinouts .....	91
Parts List .....	102

## **Apple Networking Software**

AppleShare 3.0 .....	106
AppleShare Print Server .....	106
AppleShare File Server .....	106
Third-Party File Servers .....	108
Distributed File Serving .....	108
Tips for Setting Up and Using the File Server .....	108
AppleTalk Internet Router 2.0 .....	109
Seed Routers .....	111
Starting the Internet Router .....	111
Internet Router Network Statistics .....	112
Network Information Window .....	112
Port Statistics Window .....	113
Resetting the Statistics .....	114
Connecting Networks to the Router Ports .....	114
AppleTalk Internet Router Tips .....	115
Troubleshooting Router-Related Problems .....	116
Symptom/Cure Chart .....	117
System 7 .....	120
Installing Networking Software .....	120
Software Drivers .....	120
Preparing for Network Use .....	121
Selecting AppleTalk .....	121
Selecting a Network Connection and Zone .....	121
Naming the Macintosh Computer and Its Owner .....	122
Connecting to Shared Disks or File Servers .....	122
File Sharing in System 7 .....	123
Troubleshooting System 7 Networking Problems .....	123
Symptom/Cure Chart .....	124
AppleTalk Remote Access 1.0 .....	126
Operating Requirements .....	126
Modem Support and Scripts .....	126

---

Specifications .....	127
Symptom/Cure Chart.....	127
Network Interface Software .....	130
EtherTalk 2.0.....	130
TokenTalk 2.0.....	130
Connectivity Software .....	131
MacX25.....	131
MacTCP .....	131
SNA•ps 3270 .....	131
SNA•ps Gateway.....	132
Macintosh Communications Toolbox.....	132
MacTerminal 3.0 .....	133
Data Access Language Server for VAX and VMS.....	133
Inter•Poll Network Administrator's Utility .....	134

### **General Network Troubleshooting**

General Troubleshooting Approaches .....	136
Most Common Network Problems .....	137
Cables .....	137
Cards .....	137
Individual Nodes .....	138
Power Source .....	138
Software .....	138
User Errors.....	138
Diagnostic Tools.....	139
Network Log .....	139
Network Map .....	139
Traffic Monitoring Software .....	139
Hardware Tools .....	140
Small-to-Medium Networks.....	140
Large Networks.....	140
Inter•Poll Software.....	141
Using Inter•Poll.....	141
Device List Window .....	142
Test Device Window .....	143
Troubleshooting with Inter•Poll .....	144
Missing Zone .....	144
Missing Network .....	145
Missing Workstation .....	146
Symptom/Cure Chart for General Troubleshooting .....	147





# General Information

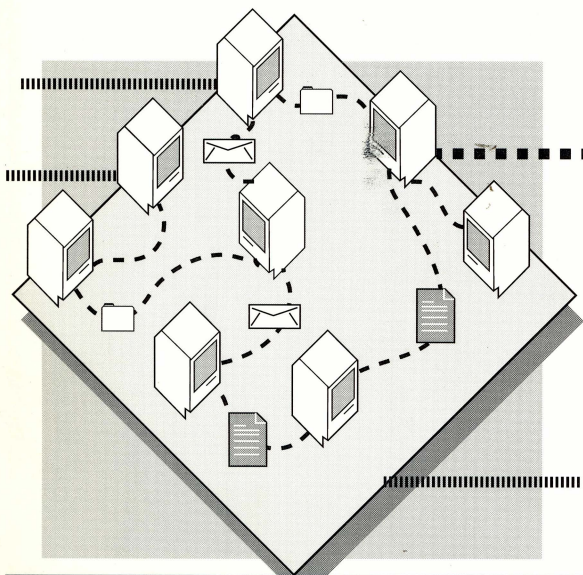

---

AppleTalk Overview	2
Network Topologies	7
Network Access Methods	10
Transmission Media	11
Network Usage Planning	13
Network Services	14

## AppleTalk Overview

AppleTalk<sup>®</sup> is Apple Computer's proprietary networking protocol architecture, which is implemented in the ROM and operating system software of most Apple computer equipment. AppleTalk serves as the basis for a broad variety of applications. These applications range from a single Macintosh computer with a few peripheral devices attached, to a network system connecting thousands of computer systems dispersed over a wide area.

Developed as a general-purpose networking system, AppleTalk supports IEEE 802.2 (Logical Link Control), 802.3 (Ethernet), and 802.5 (Token Ring) networking standards. In addition, Apple offers various implementations of the AppleTalk protocol to support VMS, UNIX<sup>®</sup>, MS-DOS, NetWare, and other operating system platforms.

Because AppleTalk is a data-link independent networking system, it operates as fast as the network you choose (see Figure 1). In addition, you can connect an AppleTalk network using a variety of transmission media, including unshielded twisted-pair cable (phone wire), shielded twisted-pair wire, thick or thin coaxial cable, fiber optic cable, infrared light, and radio signals.

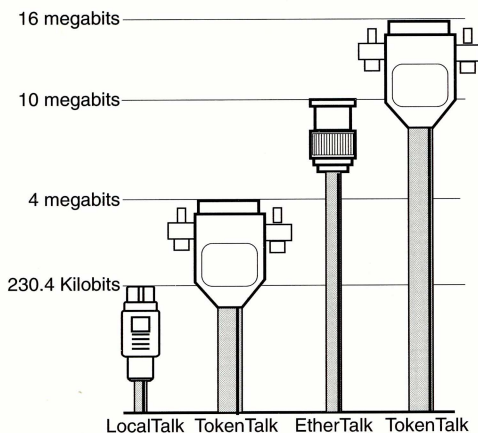

Figure 1 Network Transmission Speeds

---

There are two versions of AppleTalk—Phase 1 is the original version, which has now been replaced by AppleTalk Phase 2. Phase 1 has a limit of 254 nodes per network, does not allow for network ranges, and does not support many other features of other Apple networking software. Phase 1 may be sufficient for an existing LocalTalk<sup>®</sup> network, but **most installations will require AppleTalk Phase 2**, which allows for multiple zones and up to 16 million nodes per network.

**Note** You must upgrade to AppleTalk Phase 2 to use any AppleTalk Phase 2 products, such as TokenTalk<sup>®</sup> software or the AppleTalk Internet Router.

---

### AppleTalk Phase 2 Features

As shown in Figure 2, AppleTalk gives network users point-and-click access to all network services, including file servers, electronic mail, and networked printers.

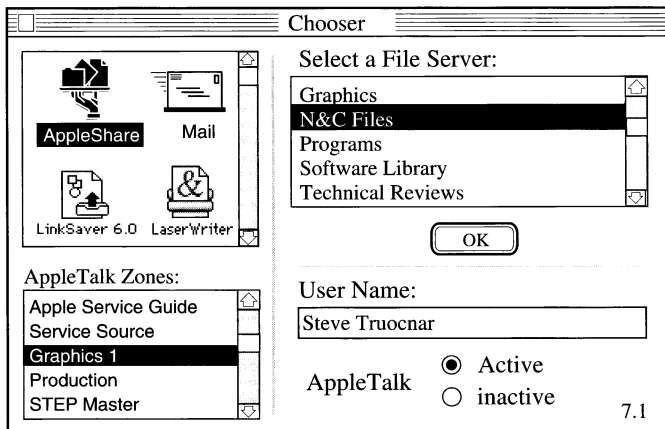

**Figure 2 AppleTalk Chooser**

AppleTalk Phase 2 allows users to take advantage of a variety of network services across different types of networks and operating platforms. Network services currently available include AppleShare<sup>®</sup> and compatible file service, print spooling, PostScript<sup>™</sup> printing on Apple LaserWriter<sup>®</sup> printers, electronic mail, and modem sharing. The following sections describe other AppleTalk Phase 2 features.

---

## **Extended Addressing**

The AppleTalk addressing scheme uses node and network numbers to identify the sender and destination of each data transmission. The data-link level protocols use these numbers to identify the individual nodes, and the network level protocols use these numbers to identify the network to which each node belongs.

AppleTalk Phase 2 supports extended addressing when used with a router. Extended addressing support means that instead of the previous limit of 254 nodes, Phase 2 can support up to 16 million network nodes.

## **Dynamic Node Addressing**

AppleTalk Phase 2 supports dynamic node addressing, which allows each node on the network to assign itself a unique node number. At startup time, each node picks its own number, either by using some information stored in parameter RAM (PRAM) or by generating a random number. The node then verifies with the network that the guessed number is not already in use on that network.

Since addresses are not fixed, the task of configuration is eliminated, and you can move nodes between networks without concern for pre-existing node numbers.

## **Distributed Name Service**

AppleTalk assigns each node in the network a name, type, and zone, each of which can be up to 32 characters in length. Each AppleTalk node can request this information from any other AppleTalk node on the network, and every AppleTalk node can respond to such a request. Thus, this service is distributed among all the nodes on the network—not localized in a server node. When users want to locate and access network resources, they can select a desired device type and zone name in the Chooser, and view the names of available devices.

## **AppleTalk Zones**

With AppleTalk Phase 2, you can assign nodes to logical groupings called zones, which you create with router

---

devices. You can define AppleTalk zone names and select a default zone for each network node when you set up a router on a network. This feature means that you can have multiple zones on a single network cable, which allows you to segment services on a large extended network. AppleTalk Phase 2 supports up to 256 zones per network.

### **Best Routing Algorithm**

AppleTalk Phase 2 has a best routing algorithm, which means that nodes keep information on how best to get to other networks.

---

### **Upgrading to AppleTalk Phase 2**

To take full advantage of AppleTalk Phase 2 functionality, you must upgrade all routers on the Internet. If you need to upgrade your routers in stages, use the AppleTalk Phase 2 Upgrade Utility.

---

**▲Warning** **Concurrent operation of Phase 1 and Phase 2 routers on the same Internet causes serious network problems unless you use the Upgrade Utility.**

---

The Upgrade Utility runs in the background on the AppleTalk Internet Router and enables that router (and its connected networks) to be part of an Internet on which Phase 1 routers still exist. If the router doesn't detect any Phase 1 routers, the utility does nothing. While the Upgrade Utility is in use, you cannot use some of the features of AppleTalk Phase 2, such as network number ranges and zone name lists.

**Note** Use the Upgrade Utility only while you are performing an incremental upgrade to AppleTalk Phase 2 or while you are waiting for an upgrade for a third-party router. The tool has an adverse affect on the AppleTalk Internet Router's performance, and you should remove the utility once the Internet is fully operational.

If you upgrade to Phase 2, you must also install the most recent version of EtherTalk<sup>®</sup> and TokenTalk networking software (version 2.0 at a minimum) on nodes using that technology. You do not need to make any changes to application software.

---

**Note**

Apple recommends that you always use the latest version of networking software, which you can find on the *Network Software Installer* (NSI) disk on AppleLink<sup>®</sup>.

---

**AppleTalk Phase 2 in an Internet Environment**

To avoid node ID conflicts on Internet networks, you should always start up routers before workstations. With AppleTalk Phase 2, routers define network numbers and zone name lists. When a workstation comes up, it looks for a router to find out valid zone names and the network number range for its network. If there is no router, the workstation picks a network number in the startup range.

If you are moving a workstation, don't start up the workstation until you connect it to the new network. When the workstation starts up, it can find out the node IDs of other workstations on the network and it won't choose an ID that already exists.

---

**AppleTalk Network Tips**

Following are AppleTalk network tips:

- To avoid node number conflicts when you move a workstation to a new network, connect the workstation to the network before starting up the workstation.
- Do not share applications over the network. Everyone needs a personal copy of the application (and all users should have the same version of the software). Then users share only the documents they create with those applications.
- Do not leave network files open when not in use. There is often overhead associated with an open file even when you're not updating it. Either close the file and reopen it when you need it, or make a copy and put it on your hard drive. Be sure to rename the file or lock it, so you don't inadvertently update the copy instead of the original file.
- Use aliases with System 7™ whenever possible. The use of aliases reduces network traffic significantly, especially login traffic.

---

## Network Topologies

Standard network topologies include bus, star, ring, and backbone (with minor variations). You can't always determine a network's topology strictly from its physical layout. More and more, the way the network controls itself (e.g., the type of polling commands it uses) determines the network's topology.

You must know a network's topology to understand how the network passes, corrects, and administers data. This knowledge is critical in planning, maintaining, and troubleshooting networks.

---

### Bus Topology

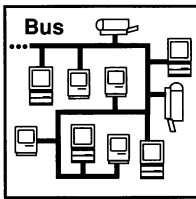

A bus topology follows a sequential layout (or trunk line) with two distinct ends, each of which must have a terminating resistor. (This restriction means that you cannot have a circular or t-shaped bus network.) Devices are attached to the bus by taps or drops, which may need to be separated by a prescribed distance.

**Note** Apple LocalTalk network cabling follows a bus topology in which network devices are laid out in a linear fashion and linked to one another through a series of connector boxes.

Transmissions on a bus are broadcast along the entire length of the cable. The receiving device, whose address matches the destination address of any network data packet, accepts and reads the packet; the other devices simply ignore it.

Bus type networks generally use one of two error recovery/avoidance schemes. Both are known as Carrier Sensing Multiple Access. One method is Collision Detection (CSMA/CD) and the other is Collision Avoidance (CSMA/CA). With Collision Detection, the network merely identifies when a packet is destroyed by a collision and resends it. With Collision Avoidance, the scheme Apple LocalTalk networks use, the network node actually listens to the network line to determine when the line is free and then transmits.

Advantages of a bus topology are that it's easy to configure and the failure of a single device won't bring down the entire

---

network. The modular design encourages a plug-and-play installation where devices are quickly and easily added to the network. Disadvantages are that a break anywhere on the network can disrupt services for all devices on the network and problems can be difficult to locate.

---

### Star Topology

A star topology has a central controlling device, or hub, with several branches radiating off of it. Each branch can have a single device or multiple devices arranged in a bus topology

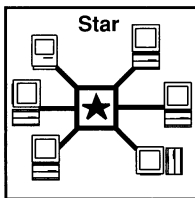

hanging off of it. Star networks generally use unshielded twisted-pair phone wire. The center of the network is usually in a phone wiring closet, where wires radiate out from a wiring block, such as a telephone punchdown block.

There are two types of star networks—active stars and passive stars. An active star has a controlling device at the hub that is connected to each device through a dedicated channel. A passive star network has a lower limit on the number of branches and total length of cable allowed.

Advantages of a star network are that it's easy to maintain and troubleshoot because devices don't share the same cable, and you can add or move devices without disrupting the network because devices are isolated. The disadvantage is that if the controller goes down, all nodes go down.

---

### Ring Topology

There are several types of ring topologies, including true ring, loop ring, and Token Ring, with Token Ring being the most common configuration.

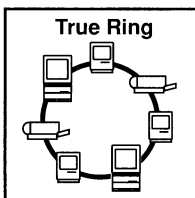

A true ring network is a closed circle, with each device wired to the next through the shortest physical path possible. A loop ring is a true ring with a central controlling device that directs transmissions. The controlling device is referred to as a Multistation Access Unit (MAU).



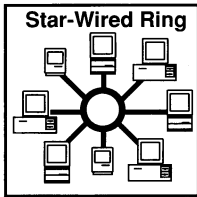

A Token Ring network, also referred to as a star-wired ring, transmits like a ring, but is grouped like a star. The network controls transmissions through the use of a token, which the devices pass in a circular fashion, allowing all devices equal access to the network. Token passing prevents collisions on the network because each device must have the token to transmit. The device with the token can transmit data uninterrupted.

Each device in the network can perform a preliminary error-check on the integrity of transmitted data. Therefore, if data arrives damaged, you can pinpoint the offending area in the network relatively easily.

Each device connects to a Multistation Access Unit (MAU), which is a central wiring concentrator. The MAU doesn't control transmissions, but contains bypass relays that enable the ring to continue operating even if a device fails. The MAU also facilitates maintenance by providing a central location for network monitoring and reconfiguration.

The advantage of the ring topology is that you can easily predict the amount of traffic additional nodes will generate as you expand your network. The disadvantage is that a Token Ring network is expensive.

---

### Backbone Topology

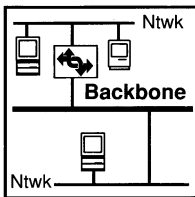

A backbone topology is like a super highway that speeds up the transmission of data. You can speed up traffic by connecting two networks using a backbone or by connecting high-usage devices like file servers directly to the backbone. A backbone network can reduce the number of routers needed and is especially useful to connect networks that aren't physically contiguous.

While you can use any type of network as your backbone, you should use the highest speed network possible—that is to say, a high-speed Ethernet or Token Ring backbone is preferable to a slower speed LocalTalk network.

More and more, a network's topology is defined by the method in which the network controls itself, rather than the actual physical layout. Therefore, it is important that you understand how any network passes, corrects, and administers data. The possible variations are described in the following sections.

---

### **CSMA (Carrier Sensing Multiple Access)**

Bus networks typically support a CSMA method of accessing the network, in which each device checks the cable before transmitting. If the device senses the network is in use, it backs off and tries again later.

---

### **CSMA/CD (Carrier Sensing Multiple Access/Collision Detection)**

The CSMA/CD method of network access adds collision detection to the CSMA method. As with regular CSMA networks, each device checks to see if the network is free before transmitting. When the network is free, however, more than one waiting device may try to send, resulting in a collision. With CSMA/CD, the network detects collisions and retransmits.

---

### **CSMA/CA (Carrier Sensing Multiple Access/Collision Avoidance)**

With the CSMA/CA method of network access, each device checks the cable before transmitting. If the network is in use, the devices wait a random amount of time before rechecking with the network. When a node sends a packet, it waits for an acknowledgment. If it doesn't receive an acknowledgment, it automatically resends the packet. (This is the method used by Apple LocalTalk networks.)

---

### **Token Passing**

In a token passing scheme, used with Token Ring networks, the node with the token has sole access to the network. The nodes can pass the token sequentially, or in a nonsequential order that is determined by the network software. There are no data collisions in a Token Ring topology because only the node with the token can transmit data.

---

## Transmission Media

The factors to consider in choosing a transmission medium include: bandwidth, the size and layout of the site, the amount of electromagnetic interference present, the ease of installation and maintenance, cost, security issues, and the existing wiring.

Depending on the network's topology, the following transmission media are available for AppleTalk Phase 2 networks (see table).

	<b>LocalTalk</b>	<b>EtherTalk</b>	<b>TokenTalk</b>
Shielded twisted pair	✓		
Unshielded twisted pair	✓	✓	✓
Thick coaxial cable		✓	
Thin coaxial cable		✓	
Fiber-optic cable	✓	✓	✓
Radio frequency	✓		
Infrared media	✓		

---

### Twisted-Pair Cable

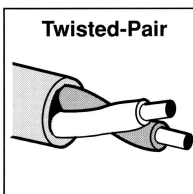

Twisted-pair cable consists of wire pairs that are individually insulated and then twisted together. It is the twisting of the wires that prevents crosstalk and interference from other cables.

Twisted-pair cable comes in two types—*shielded*, which has a shield between the wires and the outer insulation jacket that provides some extra protection from interference; and *unshielded*, which has no shielding. Unshielded twisted-pair cable is the most common medium used to connect LocalTalk networks.

---

## Coaxial Cable

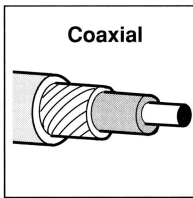

Thick coaxial cable (or thicknet), is about 1/2" in diameter and connects to nodes via a special transceiver. Thin coaxial cable (or thinnet), is about 3/16" in diameter, has a shorter span than thick coax, and typically connects to a node via a T-connector.

Ethernet networks require 50-ohm impedance RG-8 (thick coax) or RG-58 (thin coax) cable. Ethernet networks will not operate with 75-ohm television cable.

---

## Fiber-Optic

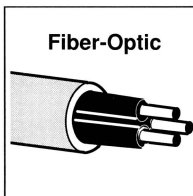

Fiber-optic cable uses light rather than an electrical current to send a transmission signal through fine fibers made of glass. Fiber optic cable transmits data at higher speeds than twisted-pair or coax cable and is immune to electromagnetic interference (EMI). Fiber optic cable supports installations that require distances of up to one mile between workstations or up to 100 users on one network.

---

## Infrared Media

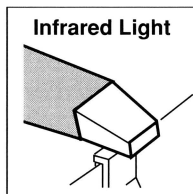

Infrared links provide for a cableless network that is not subject to EMI. In an open office, each network device is connected to a transceiver device that communicates with other transceivers by means of infrared signals bounced off the ceiling or wall. The maximum number of transceivers allowed on common infrared systems is 32, and the maximum number of nodes per subnet is 128.

---

## Radio Frequency

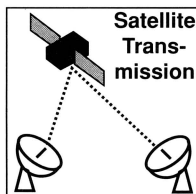

Using a range of frequencies, radio transceivers in each network node can transmit signals, which are received by other nodes on the network or by central hub transceivers that can rebroadcast the signals. Land-based microwave links provide line-of-sight network connections. Satellite links are good for long-distance communication between remote facilities, but satellite transmissions can be slow.

## Network Usage Planning

Whether you are designing a new network or adding to an existing one, it is important that you balance the network traffic to prevent bottlenecks that can affect network performance. The chart in Figure 3 illustrates the amount of network traffic you can expect from various user activities.

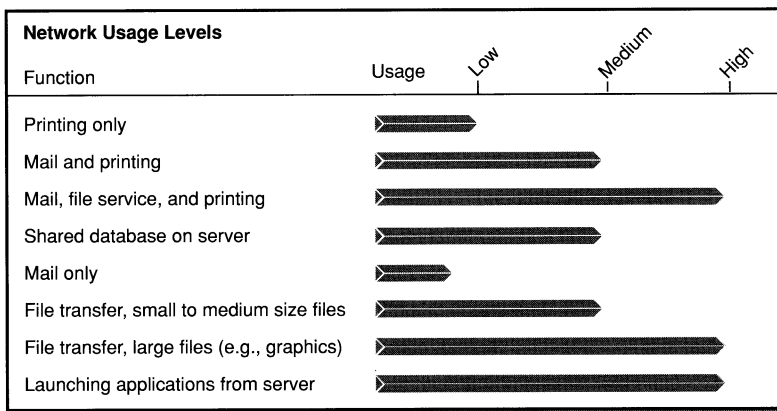

**Figure 3 Network Usage Levels**

The number of users simultaneously taking part in any of these network activities will affect the overall level of network traffic. For example, the more people simultaneously accessing a shared database on a server, the greater your traffic will be. Keep this fact in mind when deciding how many devices to attach to a network.

### Note

You can use the IEEE specifications as a guideline when determining the maximum number of devices to attach to a network, but you must factor in the amount of network resources each node will require.

---

## Network Services

Networks are powerful tools because they allow users to share information, software applications, and hardware resources, even when those users are not in the same physical location. The type of network services that make this sharing of resources possible include:

- Print services
- File services
- Electronic mail services
- Remote dial-in access to the network

---

### Print Services

Users can share printer resources on a network in two ways: the first approach is to simply connect a shared printer to the network, making it available to all users on the network; the second approach is to use a print server.

**Note** Refer to the Network Types chapter to determine if you need additional hardware to connect an Apple printer to your network type.

**Note** If you connect a printer that doesn't support AppleTalk directly to an AppleTalk network, you won't be able to select this printer through the network (i.e. through the Chooser).

### Shared Printing

With a shared printer, users can either print in the *foreground* or *background*. With foreground printing, users send documents directly to the shared printer and then must wait for their print jobs and all print jobs ahead of theirs to finish before their computers are free for other work.

Background printing requires appropriate software, such as Apple's PrintMonitor program, which is included with Macintosh<sup>®</sup> system software. When a user issues a print command, the background printing software stores the document on the user's hard disk, freeing up the computer for other work, and sends the document to the printer when the printer is free. Background printing may occasionally slow the performance of a computer until the document is actually sent to the printer.

---

## Printing with a Server

One way to share printer resources is to use a print server, sometimes called a spooler. The print server receives files to be printed and stores them when the printer is busy. As a result, users do not have to wait for printing to take place and can get back to their work more quickly.

**Note** Refer to the Apple Networking Software chapter for information on Apple computer's AppleShare Print Server software.

---

## File Services

You can have either centralized file sharing or distributed file sharing on an AppleTalk network. Both types of file sharing allow you to:

- Access and use files and applications that reside on the server
- Copy files and applications from the server to your own computer
- Store files and applications on the server so that others can readily access them.

A centralized file sharing system requires a dedicated file server—a computer with one or more attached hard drives or CD-ROM drives and the appropriate file sharing software. (Refer to the Apple Networking Software chapter for more information on Apple Computer's AppleShare File Server software.) The file server does not usually run user applications, but it may provide other network services, such as print spooling or electronic mail.

In a distributed file sharing network, every computer on the network acts as a file server and the file server software operates in the background on each user's computer.

The System 7 operating system offers built-in file sharing support that allows users to share files in a distributed file server mode. Users decide what to share and what not to share. In addition, a user can monitor which items on his computer are marked shared and which users are currently connected to his system.

---

**Note**

Performance on a computer running file sharing software will decline when the computer is being shared by others on the network.

---

**Electronic Mail Services**

Electronic mail (E-Mail) software allows users to send messages and forward files to one another over the network. Users can create a message within the E-Mail package, or send files that they have created using other software, such as a word processing or spreadsheet application.

You can have a dedicated mail server or a direct delivery (serverless) system. The main difference between the two options is that with a direct delivery system, the recipient's computer must be turned on before you can send a message, while a mail server eliminates this restriction.

---

**Remote Dial-In Services**

Remote dial-in services allow users to access a network from a remote location. Once the remote computer is connected, the user can access most network services that he could if he were connected locally.

Remote access products can be hardware or software based. Hardware-based products are dedicated "black box" devices that sit between the user's computer and a modem. Software-based products consist of remote-access software that runs on a user's computer and works in conjunction with a modem and ordinary phone lines. Access can be one-way (computer to the network) or two-way, in which the remote-access product functions as a half-bridge or half-router.

**Note**

Refer to the Apple Networking Software chapter for information on Apple Computer's AppleTalk Remote Access software.



# Network Types

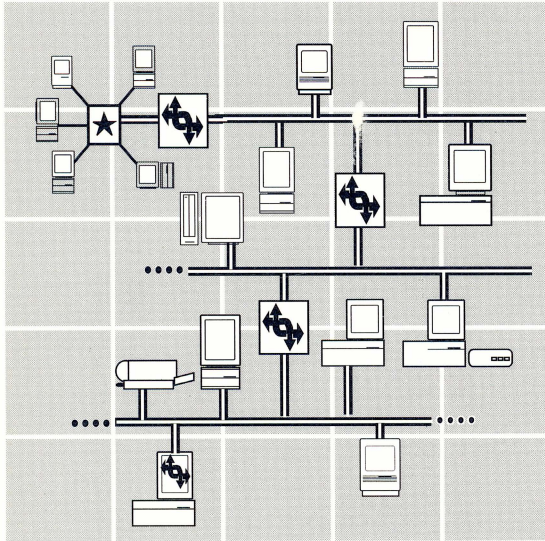

---

LocalTalk Networks	18
EtherTalk Networks	27
TokenTalk Networks	36
Expanded Networks	39
Internet Networks	40
Networking Possibilities	44
General Network Tips	46

## LocalTalk Networks

The term LocalTalk has two meanings. First, *LocalTalk* is a type of network that supports AppleTalk protocols and is well suited to small work groups with low-to-moderate amounts of network activity. LocalTalk networks provide:

- Support for AppleTalk network protocols
- A transmission speed of 230.4 Kbps
- A CSMA/CA error recovery/avoidance scheme
- Support for dynamic node ID assignment

*LocalTalk* also refers to Apple cabling products that you can use to build LocalTalk networks. The following table lists the specifications for a LocalTalk network built with Apple LocalTalk cabling.

<b>Apple LocalTalk Network Specifications</b>	
Topology	Serial bus, transformer isolated (bus must be terminated at each end)
Wiring	Shielded, twisted-pair (Apple LocalTalk connector boxes are self-terminating)
Signaling standard	EIA modified RS-422, balanced voltage
Signaling speed	230.4 Kbps
Signal encoding	FMO (bi-phase space)
Frame format	SDLC (Synchronous Data Link Control)
Max. cable length	1000 feet
Max. number of nodes	32
Node identification	Self-configuring, no user action required
RFI and noise immunity	No RFI (passive taps); common mode noise immunity greater than 500 volts

Most Apple equipment has LocalTalk network support built in, but some devices require a LocalTalk interface card to make the connection, as the following table shows.

---

### LocalTalk Connections

Device	Built-in Support	Comments
Apple IIe	No	Requires Apple II Workstation Card and software
Macintosh 128K, 512K, and 512K enhanced	Yes	Connect through 9-pin (DE-9) printer port
All other Macintosh and PowerBook™ computers, Apple IIGS®	Yes	Connect through mini DIN-8 (RS-422 serial) printer port
ImageWriter®	No	Third-party option may be available
ImageWriter II/LQ	No	Requires ImageWriter II/LQ LocalTalk Option Card
LaserWriter/LaserWriter Plus	Yes	Connect through 9-pin port
LaserWriter II, II NT, II NTX, II f, II g, and Personal LaserWriter NT	Yes	Connect through mini DIN-8 (RS-422 serial) port
PC-compatible computers	No	Require LocalTalk PC Card and software

**Note** Refer to the Apple Networking Hardware chapter for a description of all networking interface cards.

---

### Comparing LocalTalk Transmission Media

The Apple LocalTalk cabling system uses shielded twisted-pair cable, which is self-terminating as long as the connector box at each end of the network has one empty outlet. Third-party LocalTalk cables may be shielded or unshielded and may require an additional terminating resistor. The Farallon PhoneNET® cable system, for example, uses standard, unshielded phone wire and requires the addition of terminating resistors.

**Note** Refer to the Apple Networking Hardware chapter for Apple LocalTalk cable specifications.

If you use Apple LocalTalk cabling to connect the network, you **must follow a bus topology**. It makes no difference where you place devices along the bus, but the network must be in a linear configuration (you can't have a circular or t-shaped bus network) and the network must be terminated at each end.

The following table compares Apple cabling (shielded twisted pair) to third-party solutions.

<b>Medium</b>	<b>Trans. Rate</b>	<b>Topology</b>	<b>Max. Number of Devices</b>	<b>Max. Length per Network</b>
Apple's shielded twisted-pair	230.4 Kbps	Bus	32	1000 ft.
Unshielded twisted-pair	230.4 Kbps	Bus	24	1800 ft.
		Passive Star	Varies	750 ft. per branch; 4000 ft. total
		Active Star	254	3000 ft. per branch
Infrared light	230.4 Kbps	N/A	128 per transceiver	Transceivers must be within 70-ft. diameter

**Note** The specifications in the table above will vary for third-party products. The actual number of nodes you can connect will depend on network usage patterns. Check with the product manufacturer for more information.

---

### **Apple LocalTalk Cable System**

If you use the Apple LocalTalk Cable system to connect your LocalTalk network, you will need the equipment listed in the following table.

**Note** Refer to the Apple Networking Hardware chapter for a description of the Apple LocalTalk Cable system.

### Apple LocalTalk Connections

Device	Cable/ Connector Kit	Contents	Part #
Apple IIe <sup>1</sup> , IIGS; all Macintosh computers (except 128K, 512K, 512K enhanced); ImageWriter II <sup>2</sup> ; LaserWriter II NT; II NTX, II <sub>f</sub> , and II <sub>g</sub> ; Personal LaserWriter NT	LocalTalk Locking Connector Kit—DIN-8	Connector box with mini DIN-8 cable; 2-meter cable; cable extender	630-8275
Macintosh 128K, 512K, and 512K enhanced; LaserWriter and LaserWriter Plus	LocalTalk Locking Connector Kit—DE-9	Connector box with 9-pin cable; 2-meter cable; cable extender	630-8272
General purpose	LocalTalk Locking Cable Kit—10-Meter	10-meter cable; cable extender	630-8273
General purpose	LocalTalk Locking Cable Kit—25-Meter	25-meter cable; cable extender	630-8276
General purpose	LocalTalk Custom Wiring Kit	100-meter cable; assembled plugs; cable splicers; cable extenders	M2070 (finished goods part #)

1 With Apple II Workstation Card and Software  
2 With LocalTalk Option Card

### Setting Up or Adding to the Network

Remember the following when setting up or adding to a LocalTalk network:

- LocalTalk cable is waterproof, but the extender hardware is not. Do not use extenders in ceilings or raised floors that have sprinkler systems or other plumbing, or in wet areas.

- 
- Consult your local fire codes regarding wiring standards.
  - Don't place cables outdoors or where they might be stepped on.
  - Apple 2-, 10-, and 25-meter cables are not plenum rated, so you cannot run these cables through walls or suspended ceilings unless you use metal conduit. The cable in the LocalTalk Custom Wiring Kit does not require conduit.
  - Apple LocalTalk cable is self-terminating as long as the connector box at each end of the network has one empty outlet.
  - If you have a network with just two devices (for example, a Macintosh computer and a printer), use two connector boxes and only one cable. If you use two cables, you will create a circle and the network will not function properly.

---

### **Connecting Nodes**

Always use the printer port when you connect a Macintosh computer to a LocalTalk network. If another device is plugged into the printer port, move the cable to the modem port and make any necessary software changes on the startup disk (see the owner's guide for your peripheral device or computer for details).

Be sure to switch devices off before connecting them to the network. If you connect an active device, it may assign itself an identification number that is already in use on the network. You will not be able to use either device until you switch one device off and on again.

### **Adding a Device to the End of a Bus Network**

You can add a device to either end of the bus network without disrupting services. You will need a LocalTalk cable and connector box to attach a new device. Refer to the following steps and Figure 1 when adding a device to the end of the bus network:

1. Attach the new cable to the new connector box.
2. Attach the other end of the cable to the connector box on the existing network.

3. With the new device switched off, attach the connector box cable to the new device.

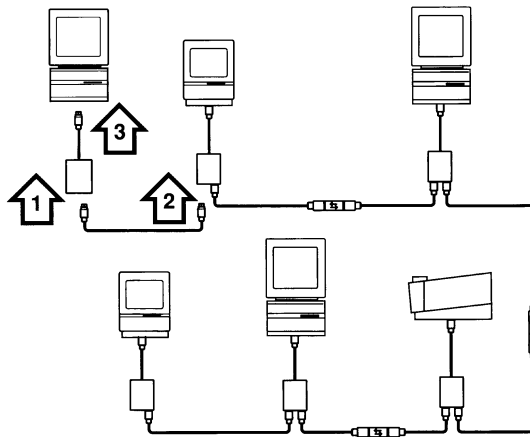

**Figure 1 Adding a Device to the End of a Bus Network**

**Note**

Be sure you don't leave a cable dangling from the last connector box as shown in Figure 2. The last connector box on either end of the network should have one empty port.

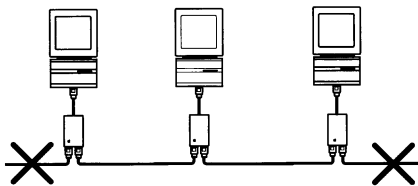

**Figure 2 Dangling Cables**

**Adding a Device Between Connector Boxes**

To add a device between two existing connector boxes, you must interrupt the network (warn users first). To add a device between two connector boxes when you have a new connector box and one cable, refer to the following steps and Figure 3.

1. Attach the new cable to the new connector box.

2. Unplug a cable from the connector box on the existing network (by pulling on the plug—not the cable).
3. Plug the other end of the new cable into the connector box on the existing network.
4. Attach the end of the cable you unplugged from the network to the new connector box.
5. With the new device switched off, attach the the new connector box cable to the device.

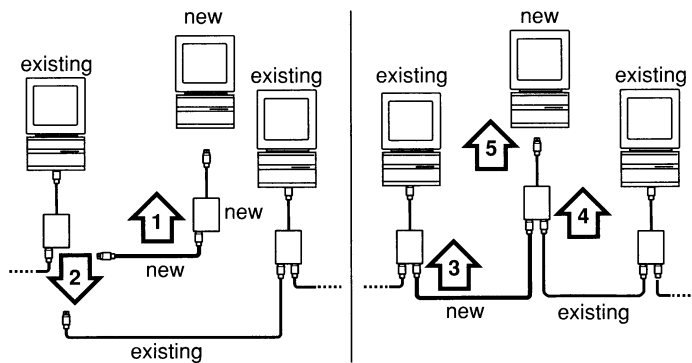

**Figure 3 Adding a Device Between Connector Boxes**

---

### Checking PhoneNET/LocalTalk Connections

Connect Farallon PhoneNet equipment on a LocalTalk network as follows:

1. Plug the mini DIN-8 end of the connector module into the printer port on the Macintosh computer or the network port on the peripheral device.
2. Make sure you have either two phone cables or one phone cable and one terminating resistor attached to the box end of the connector module.

---

### Disconnecting Nodes

Remember the following points when you disconnect nodes from an Apple LocalTalk network:

- Always switch off devices before you remove them from the network.



- LocalTalk cables have locking connectors—pull on the plug, not the cable, to disconnect them.
- To temporarily remove a device, disconnect the connector box cable from the back of the device—do not remove the LocalTalk connector box, which can stay on the network indefinitely (see Figure 4).

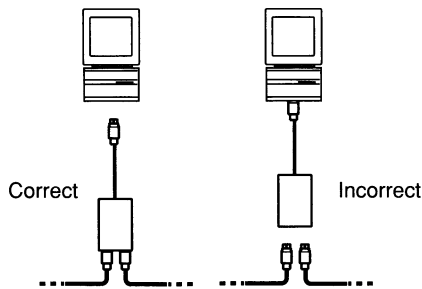

**Figure 4 Disconnecting Nodes**

- If you must remove a connector box, replace it with a cable extender.
- Don't leave any removable cables dangling.

### Symptom/Cure Chart for LocalTalk Networks

The following symptom/cure chart pertains specifically to LocalTalk networks that have Apple LocalTalk cabling. If your LocalTalk network displays one of the symptoms listed, carry out the troubleshooting steps following that symptom.

#### Note

For additional troubleshooting information, refer to the General Network Troubleshooting chapter. If your LocalTalk network is part of an Internet, you may also want to refer to the Symptom/Cure Chart for Internet Networks later in this chapter.

#### General Problems

LocalTalk network is completely down

#### Solutions

- Make sure no one disconnected a LocalTalk connector box from the network, thus breaking the network into two pieces. Users should disconnect the LocalTalk cable from their computers if they want to disconnect from the network (see Figure 4).

---

Entire Apple  
LocalTalk network  
is not functioning  
properly

1. Make sure the cabling system is not over 1,000 ft. in length and that you haven't attached more than 32 connector boxes.
2. If you only have two devices on your network, you must have two connector boxes and use only one cable to connect them.
3. Make sure there are no removable cables dangling from connector boxes (i.e., the first and last connector boxes should each have one empty outlet).
4. If you are connecting a computer, plug the LocalTalk connector box cable into the printer port.
5. Make sure all devices in question are attached to the network, switched on, and ready (printers may take a few minutes to warm up and have a steady green light).
6. Follow the cabling between the devices that are trying to communicate with one another to be sure they are connected to the same network.
7. Check and tighten all LocalTalk connections at each device, connector box, and cable extender.
8. Follow the network to be sure you don't have a circular network. If you can't find two ends of the network, disconnect one of the cables from between two connector boxes. Be sure to disconnect both ends of the cable so you don't leave a dangling cable.
9. Switch each device connected to the network off and on.

One computer on the  
network is not  
functioning properly

1. Verify that the network is connected to the printer port and not the modem port.
2. Verify that all cables and connectors are attached securely.
3. Select **Shut Down** (not **Restart**) from the Special menu, wait 30 seconds, and power on the system again.
4. Reinstall the networking and system software.
5. Replace the terminating resistor (on Farallon PhoneNET connectors only), connector module, and cable one at a time. **Important—always shut down devices before making hardware changes.**

### Printer Problems

ImageWriter II printer  
not operational

### Solutions

1. Verify that you have a LocalTalk Option Card installed and that the dip switches are set correctly.
2. Make sure that standoffs and the option card are inserted completely.
3. Check the cabling.

### Access Problems

Can't see network  
services or zones

### Solutions

- Make sure no one disconnected a LocalTalk connector box from the network, thus breaking the network into two pieces. Users should disconnect the LocalTalk cable from their computers if they want to disconnect from the network (see Figure 4).

---

## EtherTalk Networks

EtherTalk networks consist of AppleTalk protocols running over Ethernet cabling. EtherTalk networks are well suited to high-speed, high-volume networks. Characteristics of EtherTalk network include:

- Support for AppleTalk network protocols
- Transmission speed of 10 Mbps
- A CSMA/CD error recovery/detection scheme
- The ability to communicate over the same Ethernet cable with devices that obey non-AppleTalk protocols (if the appropriate software is installed)

The following table gives the specifications for a network built with the Apple Ethernet Cabling system.

<b>Apple Ethernet Thin Coax Cabling Specifications</b>	
Topology	Serial bus (must be terminated at each end with 50-ohm resistors)
Wiring	Self-terminating
Signaling standard	IEEE/ISO 802.3 10BASE-2
Signaling speed	10 Mbps
Signal encoding	Manchester
Frame format	As per 10BASE-2 standard
Max. cable length	600 feet
Max. number of nodes	30
FCC certification	Class B

Some Apple computers and peripheral devices have EtherTalk network support built in, but other Apple devices require an EtherTalk interface card. Additionally, you need an Ethernet transceiver, which can be built into an Ethernet interface card or provided as an external transceiver device, to complete the connection. See the EtherTalk Connections table that follows.

### EtherTalk Connections

Device	Built-in Support	Comments <sup>1</sup>
Macintosh Plus and PowerBook computers	No	Require third-party external SCSI to Ethernet adapter
Macintosh SE and SE/30	No	Require third-party external SCSI to Ethernet adapter or third-party interface card
Macintosh II/IIx/IIcx	No	Require at least an EtherTalk Interface or EtherTalk NB Card and EtherTalk 2.01 or later software <sup>2</sup>
Macintosh IIfx	No	Requires at least an EtherTalk NB Card and EtherTalk 2.03 or later software <sup>2</sup>
Macintosh IIcx	No	Requires at least an EtherTalk NB Card and EtherTalk 2.03 or later software <sup>2</sup>
Macintosh IIsi	No	Requires at least an EtherTalk NB card, a NuBus Adapter Card, and EtherTalk 2.03 or later software <sup>2</sup>
Macintosh LC	No	Requires Apple Ethernet LC Card and Apple Ethernet transceiver <sup>3</sup>
Macintosh LC II	No	Requires Apple Ethernet LC Card (ROM version 1.1 or later) and Apple Ethernet transceiver <sup>3</sup>
Macintosh Quadra™ Family Computers	Yes	Require Apple Ethernet transceiver <sup>3</sup>
ImageWriter and LW Printers (except IIg)	No	Third-party options may be available
LaserWriter IIg	Yes	

<sup>1</sup> Refer to "Interface Cards" in the Apple Networking Hardware chapter for the specific version of the card.

<sup>2</sup> Always use the latest *Network Software Installer* (NSI) disk, which is available on AppleLink.

<sup>3</sup> See the Apple Ethernet Media Adapters table for a list of transceivers.

**Note**

Refer to the Apple Networking Hardware chapter for a description of the Apple Ethernet interface cards and transceivers.

## Comparing EtherTalk Transmission Media

You can use the Apple Ethernet Cabling System or compatible third-party transmission media to connect an EtherTalk network. The table below compares the network specifications for Apple Ethernet Cabling (thin coax) to third-party solutions.

<b>Ethernet Transmission Media Comparison</b>			
	<b>Apple Thin Coax (10BASE-2)</b> ● <b>Bus Topology</b>	<b>Thick Coax (10BASE-5)</b> ● <b>Bus Topology</b>	<b>Twisted-pair (10BASE-T)<sup>1</sup></b> ● <b>Active-Star Topology</b>
<b>Min. Distance Between Nodes</b>	1.6 ft	8.2 ft	N/A
<b>Max. Length per Segment</b>	600 ft	1,640 ft	328 ft <sup>2</sup>
<b>Max. Length per Network<sup>3</sup></b>	2,400 ft	8,200 ft	328 ft from hub <sup>2</sup>
<b>Max. Number of Devices</b>	30/segment <sup>4</sup>	100/segment <sup>4</sup>	1,024
<b>Transmission Speed</b>	10 Mbps	10 Mbps	10 Mbps
<b>Standard Supported</b>	IEEE 802.3	IEEE 802.3	IEEE 802.3

1 Each Macintosh computer must have an Ethernet interface with 10BASE-T transceiver built in or a built-in AUI port connected to a separate external 10BASE-T transceiver.  
 2 Tested to this length for compliance with IEEE specifications.  
 3 With the use of repeaters.  
 4 Segment figure is for contiguous length of cable without repeaters.

**Note** This Ethernet Transmission Media Comparison table provides standard recommendations. Some third-party product specifications may differ. Check with the product vendor or the IEEE 802.3 specification for more information.

---

If you use Apple Ethernet thin coax cable to set up your network, **you must follow a bus topology**. It makes no difference where you place devices along the bus, but the network must be linear (not circular or t-shaped) and the network must be terminated at each end.

**Note** Apple Ethernet cabling and media adapters are self-terminating. Third-party cabling requires 50-ohm terminators.

---

### Apple Ethernet Cable System

The following table indicates the various Ethernet media adapters Apple provides and the media type to which they connect.

Apple Ethernet Media Adapters	
Product	Connects To
Apple Ethernet Thin Coax Transceiver	Thin coax Ethernet cable
Apple Ethernet Twisted-Pair Transceiver	Twisted-pair Ethernet cable
Apple Ethernet AUI Adapter	External transceivers for fiber-optic, thick coax, and other Ethernet media types

Because Apple separates the transceiver from the interface card, you can use the appropriate media adapter to switch cabling systems without having to replace your interface card.

**Note** Refer to the Apple Networking Hardware chapter for more information on Apple Ethernet adapters.

---

### Setting Up or Adding to the Network

In addition to the information in the Ethernet Transmission Media Comparison table, refer to the following specifications when setting up your EtherTalk network.

---

## Using Thin Coax Cable

The following tips pertain to EtherTalk networks that use thin coax cable.

- You must terminate both ends of most third-party Ethernet thin coax cable with 50-ohm terminators. (The Apple Ethernet Thin Coax Transceiver and cable is self-terminating and does not require additional hardware.)
- If connecting without an Apple transceiver, attach the T-connector directly to the workstation. See Figure 5.

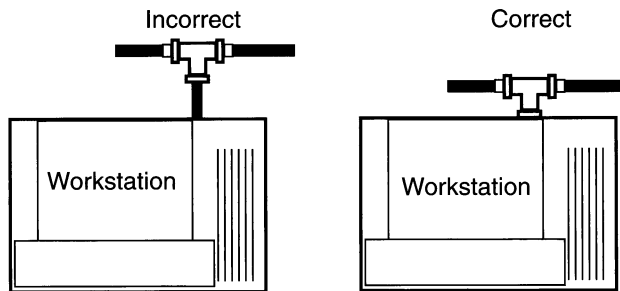
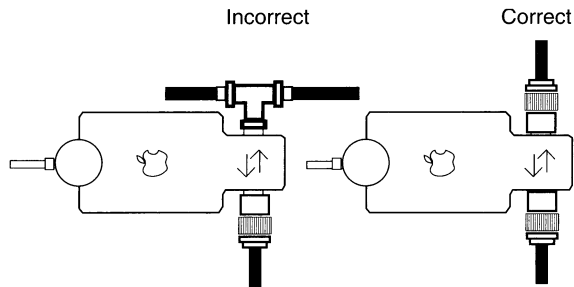

**Figure 5 Attaching a BNC T-Connector Directly to the Device**

- If you are using repeaters, no node should be more than two hops (i.e., two repeaters) away from another node.
- Never configure the cable in a loop—always make sure one connector is empty.

## Using the Apple Ethernet Thin Coax Transceiver

The Apple Ethernet Thin Coax transceiver replaces the standard T-shaped connector that connects a network device to the main Ethernet cable in conventional thin-cable installations. Do **NOT** attach a BNC T-connector to the Apple Ethernet Thin Coax Transceiver—you will cause a catastrophic network failure. Rather, connect the thin coax cable directly into one of the BNC connectors on the transceiver. See Figure 6.



**Figure 6 Attaching Thin Coax to an Apple Transceiver**

### Using Thick Coax Cable

The following tips pertain to EtherTalk networks that use thick coax cable.

- You must terminate both ends of most standard Ethernet thick coax cable with 50-ohm terminators.
- The Apple Ethernet AUI adapter is self-terminating so you can leave the adapter connected to the network when you disconnect a node.
- If you are using repeaters, no node should be more than two repeaters away from another node. 10BASE-T hubs qualify as repeaters.
- You must plug the Apple Ethernet AUI adapter into an AC outlet.

### Using Twisted-Pair Cable and Apple Transceivers

The following tips pertain to EtherTalk networks that use twisted-pair cable and Apple transceivers.

- Make sure your 10BASE-T hub supports link integrity and Signal Quality Error (SQE).
- Make sure your installation wiring is configured properly for Ethernet (e.g. standard one-pair telephone wire will not support Ethernet). Certify the wiring with a wire scanner if you are unsure,

#### **Note**

Apple Ethernet cabling and the Apple Ethernet Twisted-Pair Transceiver are self-terminating.



---

## Using Fiber-Optic Cable

The following tips pertain to EtherTalk networks that use fiber-optic cable.

- Fiber-optic repeaters should not be more than 3,279 ft. apart.
- A fiber-optic repeater and a fiber-optic bridge should not be more than 4,918 ft. apart.
- Fiber-optic bridges should not be more than 6,557 ft. apart.

---

## Starting Up an EtherTalk Network

To prevent node ID conflicts, always start up routers before you start up workstations. Refer to the Starting Up an Internet Network later in this chapter for more information.

---

## Symptom/Cure Chart for EtherTalk Networks

The following symptom/cure chart covers EtherTalk networks. If your EtherTalk network displays one of the symptoms in the chart, carry out the troubleshooting steps following that symptom.

**Note** For additional troubleshooting information, refer to the General Network Troubleshooting chapter. If your EtherTalk network is part of an Internet, you may also want to refer to the Symptom/Cure Chart for Internet Networks later in this chapter.

<b>General Problems</b>	<b>Solutions</b>
Poor performance on an EtherTalk network	– Verify that each node has the appropriate EtherTalk or Ethernet Interface Card installed, if required, and the most recent version of networking software. Refer to the Apple Networking Hardware chapter for more information.
Twisted-pair Ethernet network is down	<ol style="list-style-type: none"><li>1. Use a cable tester to make sure the polarity of the cables is correct.</li><li>2. Check the network cabling and connections.</li><li>3. Make sure the transceiver is displaying a green light. If you do not see a green light, you could have a polarity or link integrity problem.</li><li>4. If you are using an Apple Ethernet NB card, be sure the green LED is on, which indicates that the card is working. The green LED should be on even if you are not connected to EtherTalk.</li></ol>

---

Problems with a thin coax EtherTalk network

– *Nodes Using BNC T-Connectors*

1. Verify that the BNC T-connector is plugged securely into the round Ethernet connector on the back of the node.
2. Verify that there is a good, tight connection where the BNC T-connector meets the cable.
3. Verify that each end of the BNC T-connector has a terminated RG-58 coax cable or 50-ohm terminating resistor attached.

*Nodes Using Apple Thin Coax Transceivers*

1. Verify that the transceiver is plugged securely into the Ethernet connector on the back of the node.
2. Verify that there is an Apple self-terminating coax cable (or a third-party coax cable with a 50-ohm terminating resistor) attached to each end of the transceiver.

**Important—Do NOT attach a BNC T-connector to either end of the transceiver. Doing so will cause various network problems. See Figure 7.**

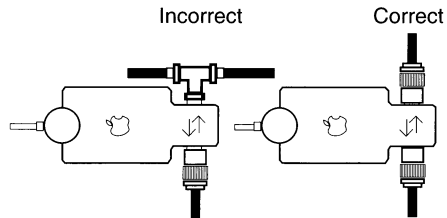

**Figure 7 Attaching Thin Coax to an Apple Transceiver**

Problems with a thick coax EtherTalk network

1. Make sure you are using the proper AUI adapter.
2. Make sure the AUI adapter is plugged into a power source.
3. Check the network cabling and connections.

Problems with only one computer on the network

1. Select **Shut Down** (not **Restart**) from the Special menu on the computer that is having problems, wait 30 seconds, and power on the computer again.
2. Refer to the tips listed under the "Poor Performance on an EtherTalk network" symptom.
3. Make the following hardware changes. **Important—Be sure to shut down all computers (and unplug Macintosh Quadra computers) before trying the next tips:**
  - a. If you are using an Apple Ethernet interface card, be sure the card is properly seated and connected to a properly terminated network.
  - b. If you are using an EtherTalk or EtherTalk NB Card, make sure the jumper on the card is configured for the

---

appropriate connection: AUI or thin coax (the DIX setting = AUI; the BNC setting = thin coax).<sup>1</sup>

- c. If using an Ethernet interface card, replace it with a known-good card.
4. Reinstall the EtherTalk software.<sup>2</sup>

### **Error Messages Appear**

Error message appears when you select EtherTalk option

### **Solutions**

- Be sure the BNC T-connector or Apple Thin Coax Transceiver is properly terminated. (Refer to the "Poor performance on an EtherTalk network" symptom.)

Software not properly installed messages appear

1. If using System 7 Tuneup, activate the AppleTalk option in the Chooser and restart the computer.
2. Reinstall the network and system software.

Message indicating absence or appearance of AppleTalk router

- The first router on the network may have come up after EtherTalk was started. Click on the EtherTalk icon in the Control Panel to restart EtherTalk. You may also need to select a zone name in the dialog box that appears.

Message indicating a node's saved AppleTalk zone is invalid

- If you moved the node to a new network, the zone name saved in the node's PRAM may not match the router's zone names. The node will automatically be placed in the default zone. You can select a different zone via the Control Panel.

### **Network Control Panel Problems**

Don't know how to check the Network control panel

### **Solutions**

1. Bring up the Chooser, activate the AppleTalk option, and restart the computer.
2. From the Apple menu, select Control Panel(s).
3. Click (System 6) or double-click (System 7) the Network icon. The Network window appears.
4. Is the EtherTalk icon selected? If not, click the icon name to select it.
5. Close the Network window (System 7 systems only).
6. Close the Control Panel window.

EtherTalk icon does not appear in the control panel

- This icon appears only if your system has Ethernet support (a built-in Ethernet port or an Ethernet interface card) and the EtherTalk software installed. If you add the card after installing system software, use the Custom Install option on the Installer program to install the specific software.<sup>2</sup>

---

<sup>1</sup> If the red LED on the card is lit, the card is configured for thin coax; if not, the card is configured for AUI.

<sup>2</sup> Apple recommends that you use the most recent version of the networking software, which is available on the *Network Software Installer* disk on AppleLink.

Token Ring networks were originally designed to connect IBM mainframes to PCs. When AppleTalk protocols are transmitted over industry-standard (IEEE 802.5) Token Ring networks, the result is an *Apple TokenTalk network*. TokenTalk networks are well suited to environments with very high data traffic requirements. TokenTalk networks provide:

- Support for AppleTalk network protocols
- Transmission speed of 4 or 16 Mbps
- A token-passing network access scheme
- The ability to communicate over the same Token Ring cable with devices obeying non-AppleTalk protocols, provided the appropriate software is installed

Each Token Ring device connects to a multistation access unit (MAU) via a lobe; a lobe is the wiring between the node and the MAU. You can connect a number of MAUs to form the main ring of the network; each MAU supports up to eight devices. A single Token Ring network can support a maximum of 260 nodes.

Token Ring networks usually appear as closed rings. Some Token Ring networks, such as the IBM Token Ring, look like a star, but logically operate as a ring. The IBM Token Ring network uses a token-passing scheme in which the node that has the token has sole access to the network. The token can be passed in sequential order or in a nonsequential order. The network software determines the order.

Macintosh family computers with NuBus™ support connect to 4 or 16 Mbps Token Ring networks via the Apple Token Ring 4/16 Card (an intelligent NuBus card). (Third-party companies sell interface cards that connect Macintosh SE and SE/30 computers to Token Ring networks.)

The Token Ring 4/16 Card comes with a DE-9 connector for attachment to IBM Type 1 and 2 (shielded twisted-pair) cable systems. Third-party adapters allow you to connect the card to Type 3 (unshielded twisted-pair) cable.

---

**Note**

Refer to the "Interface Card Connector and Cables" section in the Apple Networking Hardware chapter for more information on TokenTalk NB connections.

---

**Comparing TokenTalk Transmission Media**

You can use shielded or unshielded twisted-pair cable to connect your TokenTalk network. The following table compares transmission media.

<b>Token Ring Transmission Media</b>				
<b>Medium</b>	<b>Transmission Rate</b>	<b>Topology</b>	<b>Maximum Number of Devices</b>	<b>Maximum Length per Network</b>
Shielded twisted-pair (IBM Type 1)	4/16 Mbps	Star-wired ring	260/ring	990 ft. from MAU to node
Unshielded twisted-pair (IBM Type 3)	4/16 Mbps	Star-wired ring	72/ring	330 ft. from MAU to node

---

**Starting Up a TokenTalk Network**

To prevent node ID conflicts, always start up bridges, repeaters, and routers before you start up workstations. Refer to Starting Up an Internet Network later in this chapter for more information.

---

**Multistation Access Unit (MAU)**

It is fairly easy to troubleshoot cable problems on a Token Ring network because all cables run into a MAU. You can test any cable by performing a simple continuity test. There are also hardware devices that allow you to test the ports on the MAU. If you suspect you have a problem with the MAU itself, refer to the user's manual for the device.

Another advantage of a MAU is that it provides some fault protection. If a network device fails, the MAU to which it is connected simply bypasses that device and the rest of the network operates uninterrupted.

---

## Symptom/Cure Chart for TokenTalk Networks

The following symptom/cure chart covers TokenTalk networks. If your TokenTalk network displays one of the symptoms in the chart, carry out the troubleshooting steps next to that symptom.

**Note** For additional troubleshooting information, refer to the General Network Troubleshooting chapter. If your TokenTalk network is part of an Internet, you may also want to refer to the Symptom/Cure Chart for Internet Networks later in this chapter.

### Error Messages

Message indicates absence or appearance of AppleTalk Router

### Solutions

- The first router on the network may have come up after TokenTalk was started. Click on the TokenTalk icon in the Control Panel to restart TokenTalk. You may also need to select a zone name in the dialog box that appears.

Message indicates a node's saved AppleTalk zone is invalid

- If you moved the node to a new network, the zone name saved in the node's PRAM may not match the router's zone names. The node will automatically appear in the default zone. You can select a different zone via the Control Panel.

Message indicates error in switching to TokenTalk and going back to LocalTalk

1. Check that all cable connections are secure and that the user is connected to a MAU.
2. Verify that the MAU is switched on and working.
3. Verify that AppleTalk is activated.
4. Reinstall your system and networking software.

### Control Panel Problems

TokenTalk icon does not appear in the control panel

### Solutions

- This icon appears only if you have a Token Ring interface card installed. If you add the card after installing system software, use the Custom Install option on the *Installer* program to install the specific software.

### Access Problems

Users can't access network services

### Solutions

1. Check to see if the network appears in the Chooser.
2. Check the cables at the MAU (ring-in and ring-out).
3. Verify that AppleTalk is activated.
4. Reinstall the network and system software on the workstations.
5. Replace the MAU.

---

## Expanded Networks

If you do not exceed the network node limit, you can usually expand an existing network simply by adding more devices. For example, if you have a LocalTalk network with fewer than 32 nodes, you can extend the network at any connector box that has a free port. Or you can disconnect devices and rearrange the network layout to accommodate the new devices.

However, if adding a device causes you to exceed the limit on the number of devices allowed on a particular type of network cable, or if you are trying to extend a segment of the network cable beyond its recommended maximum length, you must add a repeater or bridge to expand the network.

---

### Repeaters

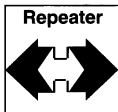

Repeaters expand the length of a network cable. Repeaters have no intelligence; they merely amplify signals. These devices extend the length of a network past its recommended maximum length by reamplifying signals and retransmitting them along the cable. Repeaters do not extend a network past its inherent node limitation, however. In addition, the cabling and protocols used on both sides of the repeater must be the same.

Repeaters expand a single network, but do *not* create two networks. Repeaters do not degrade or improve performance on a network—they merely match network performance. An AppleTalk network can have up to three repeaters to extend the maximum length of the network.

---

### Bridges

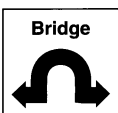

Bridges act like traffic cops on the network. Bridges join two AppleTalk network segments into an expanded network and help to manage traffic between the segments. Bridges do *not* create an Internet; each network segment is still governed by its own capabilities and limitations. You must use a router to create an Internet. Refer to "Internet Networks" later in this chapter.

When you connect multiple networks, of the same or different topologies, so that they function as a single network, the resulting network is an *Internet*. You must use a router to create an Internet.

---

### Routers

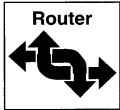

You can use a router to isolate high-traffic areas from low-traffic areas, gather network monitoring information, and divide networks into zones. Each router on an Internet maintains a logical map and routing table of the network. This map and table indicate the location of other routers in the Internet and show the most efficient route for each packet of data.

Routers are dedicated hardware devices or software that runs on a dedicated or nondedicated computer. *AppleTalk Internet Router* software, for example, enables an Apple Macintosh computer to serve as the router. (Refer to the Apple Networking Software chapter for more information on the *AppleTalk Internet Router* software.)

You can use routers in one of three ways:

- **Local Router**—connects networks that are in close proximity.
- **Half Router**—connects remote networks over a long-distance telecommunications link. Each network connects to a router, which in turn connects to a modem.
- **Backbone Router**—a local or half-router that connects networks through a backbone network, which allows you to link networks in a manner other than end-to-end.

You must identify each network you connect through a router with a network number or range. When you connect multiple routers to an AppleTalk network, AppleTalk protocols require that *at least one* router contain the identifying information (the network range, zone list, etc.) for that network. The router that contains this information is called the seed router for that network.

Most low-cost routers, including the AppleTalk Internet Router, don't distinguish the speed of a network when



---

choosing a data path. These routers simply look for the fewest number of hops (or routers) between two nodes when determining the most efficient data path.

One technique that can prevent network downtime in case of router failures is redundant routing—allowing for two possible data paths. If both paths have the same number of hops, however, troubleshooting the network is complicated because you can't tell which path the data is taking.

---

## Gateways

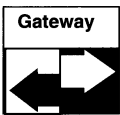

Gateways connect AppleTalk networks to networks that use non-AppleTalk protocols, such as TCP/IP or DECnet. Gateways serve as translators between otherwise incompatible network protocols. These devices interpret network-related information (such as addressing and routing instructions) in a data transmission and then translate this information into the format of the protocols running on the connected network.

For example, in the IBM environment, the Apple SNA•ps™ Gateway software runs on a Macintosh computer that has an intelligent interface card. This gateway Macintosh computer speaks the appropriate SNA protocols to the mainframe host, while distributing host connectivity sessions to user workstations on the attached network via AppleTalk protocols.

---

## Backbone Networks

Backbone networks speed up data transmissions between segments of an Internet. They are extremely useful in creating an efficient Internet layout. You can use a backbone network to connect many separate networks to each other or to connect networks that are not physically contiguous.

The primary function of a backbone network is to transport information between other networks in the most efficient manner possible. In Figure 8, none of the networks connected to the backbone is more than two hops away from any other network.

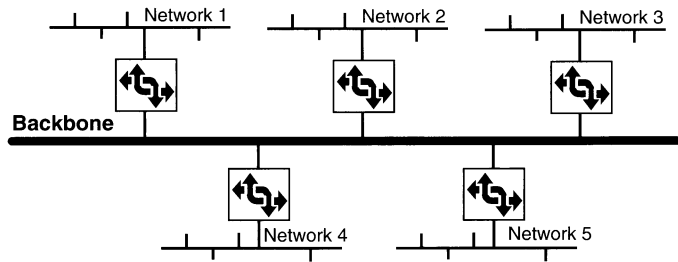

**Figure 8 Backbone Network**

Any type of network that connects to a router can be set up as a backbone. But while any backbone can provide the efficiency of fewer hops between networks, an Ethernet backbone will also enhance performance by transmitting data at the fastest rate possible. The levels of use and performance needs of your own Internet should dictate your backbone selection.

**Note** Connecting network nodes directly to a backbone permits faster access to heavily used devices, such as file servers.

---

### **Starting Up an Internet Network**

To prevent node ID conflicts, always start up repeaters, bridges, and routers before you start up workstations. If the first router on a network comes up after the Apple networking software has started on a workstation, the software will instruct the user to restart EtherTalk or TokenTalk at that workstation in order to get a valid network number. You can restart EtherTalk or TokenTalk by clicking on the appropriate icon in the Control Panel. You may also need to pick a zone name.

With Apple networking software, when you move your workstation to a different network, the zone names on the new network may be different from the zone name in your workstation's PRAM. You will see an error message telling you that the node's saved AppleTalk zone was invalid. The node will appear in the default zone that the router defines. Use the Network Control panel to select a zone name other than the default.

---

## Symptom/Cure Chart for Internet Networks

The following symptom/cure chart covers problems that are specific to Internet networks. If your Internet displays one of the symptoms in the chart, carry out the troubleshooting steps next to that symptom.

**Note** For additional troubleshooting information, refer to the General Network Troubleshooting chapter.

### Access Problems

### Solutions

Nodes on different segments of an Internet can't communicate with each other

1. Make sure there aren't more than 15 hops between the nodes.
2. If you are running multiple protocols over an Ethernet network or connecting both Macintosh and MS-DOS computers to a single PTE LAN, the Macintosh computers and AppleShare won't be able to see the MS-DOS machines.

Can't access another zone on an Internet

1. Verify that the router connecting the two zones is switched on and functioning properly.
2. If the network is a Token Ring network, check the MAU connections.
3. Swap the MAU.

### Network Degradation

### Solutions

Performance on one zone of an Internet is degraded

1. Use AppleTalk Internet Router software to see if there is an excessive amount of traffic from one zone to the other. If so, look at possible ways to reduce cross traffic by moving shared resources to the zone that uses them most often.
2. Refer to the "General delays on the network" symptom in the Symptom/Cure chart in the General Network Troubleshooting chapter.

Performance on an Internet with redundant routing is degraded

- If both data paths have the same number of hops, disconnect the redundant router so you can determine which data path is degraded.

## Networking Possibilities

The following illustration shows some of the AppleTalk networking possibilities.

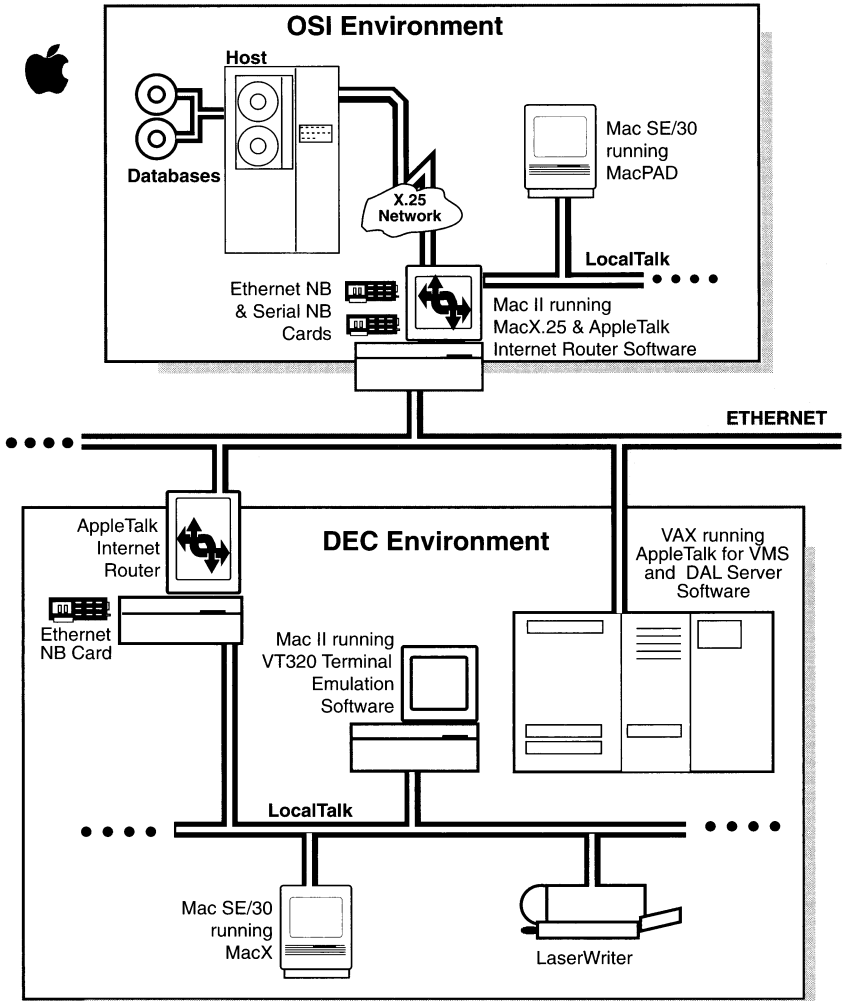

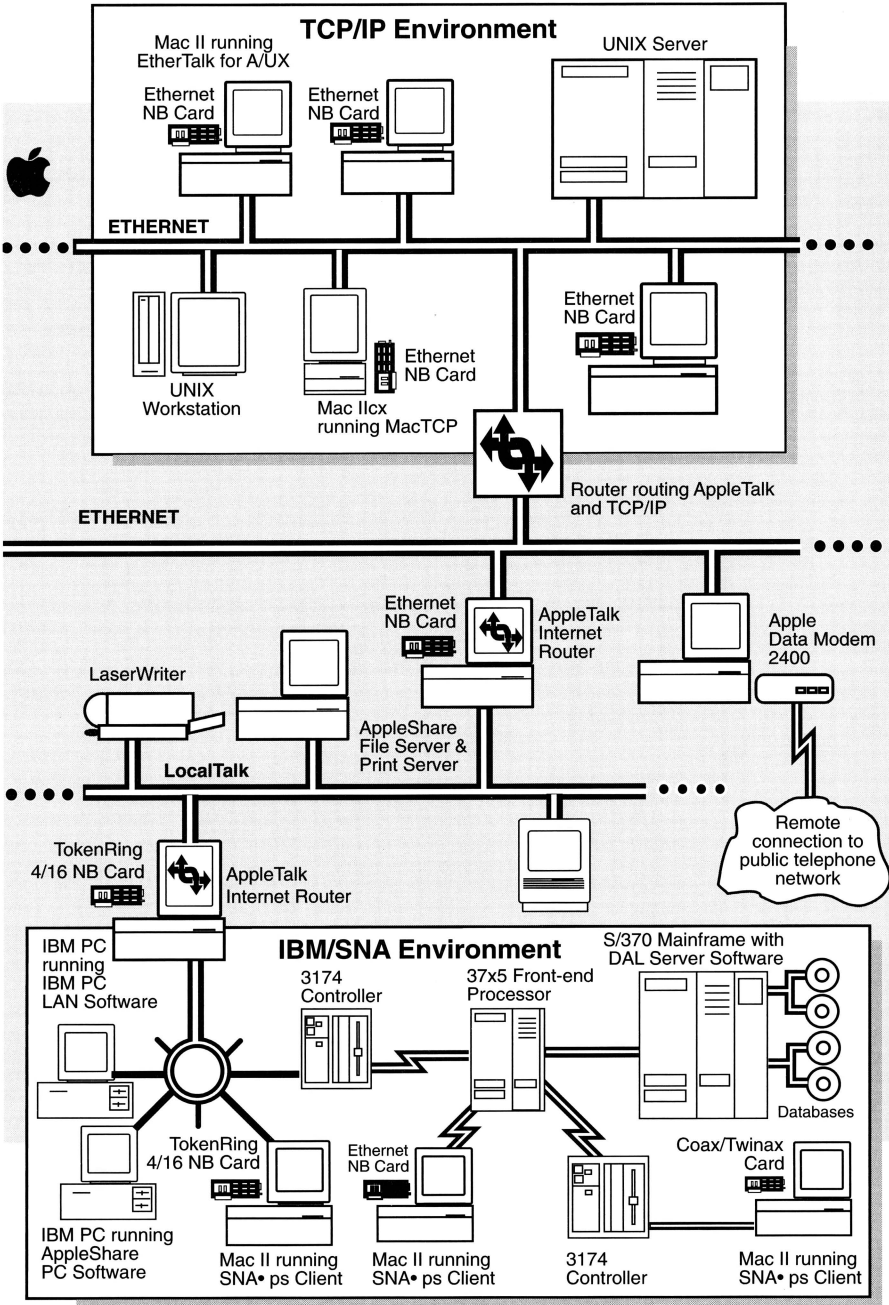

---

## General Network Tips

Following are general tips for setting up and maintaining an AppleTalk network.

---

### Tips for Setting Up an AppleTalk Network

- Create a map when you design your network, and keep the map updated. Use the map to keep track of network changes and troubleshoot network problems.
- On a single network, it makes no difference where you place shared resources. On an Internet, however, you should put shared devices and the users that plan to access them most on the same network (i.e., try to avoid data paths that go through routers) or else put shared devices on a backbone that all networks can access easily.
- Don't ever staple twisted-pair cable to walls. Stapling might cause breaks in the cable.
- Label network cables with a logical numbering sequence and show where they come from and what they connect to. Include the network number or network range on the label. Color coding (for different floors for example) also helps.
- To accommodate growth, allow for at least twice the current number of nodes when setting up a router range. Skip numbers between ranges. For example, if you set one range at 100-110, start the next at 120, instead of 111.

---

### Tips for Maintaining an AppleTalk Network

- Keep a network logbook to record network activity and changes made to the network. Print a device list when your network is new or anytime you add or rename a device. Keep the lists in your logbook.
- To gather information about network utilization, generate network reports by using Inter•Poll<sup>®</sup> or network service software (such as print service, file service, or E-Mail service). Use these reports to analyze the current state of

---

network activity. File them in your network logbook for later reference and comparison.

- To help optimize network performance over time, gather representative traffic data (use a program such as *TrafficWatch*) routinely. After you make changes to the network, compare previous and current reports to discover differences that may indicate problems. If you see excessive traffic on an Internet, try relocating or adding servers, printers, or computers to balance traffic.
- Don't let kinks develop in network cable (especially coaxial cable).





# Apple Networking Hardware

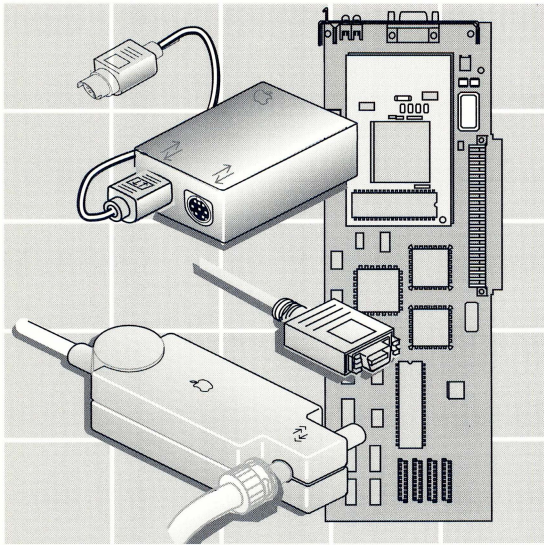

Interface Cards	50
Troubleshooting Interface Cards	62
Interface Card Connectors and Cables	67
Apple LocalTalk Cable System	68
Apple Ethernet Cable System	71
Apple Ethernet Cable System Specifications	74
Modems	76
Troubleshooting Modems	80
Modem Specifications	85
Pinouts	91
Parts List	102

## Interface Cards

By installing the appropriate Apple interface card and software, you can connect Macintosh family computers, Apple IIe computers, MS-DOS computers, and ImageWriter printers to one of the following network types: LocalTalk, Ethernet, Token Ring, or ISDN.

### Apple II Workstation Card

The Apple II Workstation Card (Figure 1) and AppleShare IIe Workstation software allow you to connect an Apple IIe enhanced computer to a LocalTalk network.

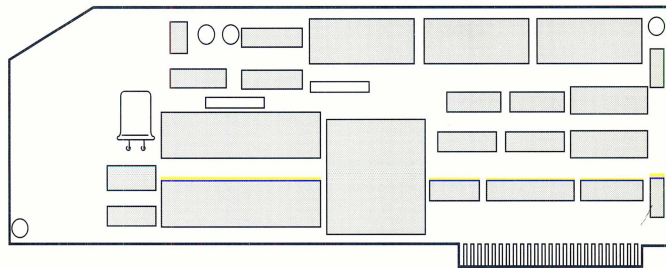

Figure 1 Apple II Workstation Card

### LocalTalk PC Card

The LocalTalk PC Card (Figure 2) connects a PC-compatible computer to any AppleTalk network, allowing you to print documents on any LaserWriter printer attached to the network.

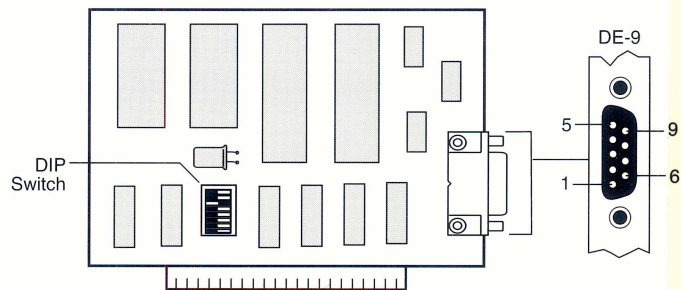

Figure 2 LocalTalk PC Card

---

With additional software, PC-compatible computers equipped with the LocalTalk PC Card can access other network services on the AppleTalk network, including file sharing and electronic messaging.

**Note** To ensure compatibility between the LocalTalk PC Card and third-party software, replace the ROM with revision C (P/N 342-007-C) or higher.

Use the eight-position DIP switch (SW1) to define how the LocalTalk PC Card will communicate with the PC-compatible computer. Select the interrupt request level, DMA channel, and I/O port addresses by setting this switch as shown in the following table.

<b>LocalTalk PC Card Switch Settings</b>		
<b>Switch Position</b>	<b>Standard Setting</b>	<b>Switch Function</b>
1	Off	Interrupt Request - Level 4
2	On	Interrupt Request - Level 3
3	Off	Interrupt Request - Level 2
4	Off	DMA Request - Channel 3
5	On	DMA Request - Channel 1
6	Off	DMA Acknowledge - Channel 3
7	On	DMA Acknowledge - Channel 1
8	On Off	I/O Port Addresses \$24X I/O Port Addresses \$22X

---

## Apple EtherTalk Interface and EtherTalk NB Cards

The Apple EtherTalk Interface Card (Figure 3) and EtherTalk NB Card (Figure 4) allow you to connect a Macintosh II family computer to an Ethernet network using the 802.3 IEEE standard. The cards support both thick and thin Ethernet coaxial cabling. Although each card contains an on-board transceiver, you must use an external transceiver when connecting to thick Ethernet coax cable.

The Apple EtherTalk Interface and EtherTalk NB Cards allow you to send and receive files over an Ethernet network. These cards are supported by the A/UX<sup>®</sup> and Macintosh operating systems, and both cards support a variety of networking protocols, including AppleTalk, TCP/IP, and the Network File System (NFS).

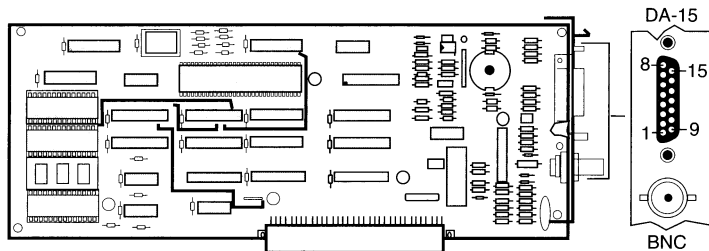

**Figure 3 Apple EtherTalk Interface Card**

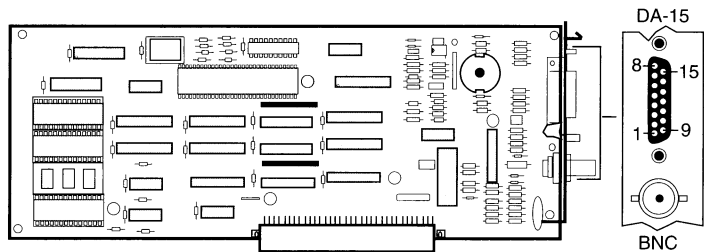

**Figure 4 Apple EtherTalk NB Card**

To ensure compatibility between the EtherTalk card, EtherTalk software, and Macintosh computer, refer to the following compatibility table.

<b>EtherTalk Compatibility</b>		
<b>CPU</b>	<b>EtherTalk Card</b>	<b>EtherTalk Software*</b>
Macintosh II/Ix	EtherTalk (Rev J or K) EtherTalk NB (Rev L or M)	EtherTalk 2.0.1 or greater
Macintosh IIcx	EtherTalk (Rev K) EtherTalk NB (Rev L or M)	EtherTalk 2.0.1 or greater
Macintosh IIci	EtherTalk NB (Rev L or M)	EtherTalk 2.0.3
Macintosh IIfx	EtherTalk NB (Rev L or M)	EtherTalk 2.0.2 or greater
Macintosh IIsi	EtherTalk NB (Rev L or M) (requires adapter card)	EtherTalk 2.0.3
Macintosh Quadra 700	Built-in Ethernet Support	EtherTalk 2.0.3
Macintosh Quadra 900/950	Built-in Ethernet Support	EtherTalk 2.0.3

\* This table lists the minimum EtherTalk software version required. However, Apple recommends that you always use the most current software version, which is available on the *Network Software Installer* disk on AppleLink.

---

## Apple Ethernet NB Card

The Apple Ethernet NB Card (Figure 5) allows you to connect a Macintosh II family computer to an Ethernet network using the 802.3 IEEE standard. The card has a built-in 68000 microprocessor, 512 kilobytes of RAM, 128 kilobytes of erasable programmable read-only memory (EPROM), and the card executes a real-time multitasking operating system.

The Apple Ethernet NB Card includes an Apple Ethernet port (AAUI port). With the addition of the appropriate Apple Ethernet Cable System media adapter, Ethernet NB Cards can connect to any standard Ethernet cabling environment: thin coax, thick coax, or unshielded twisted-pair.

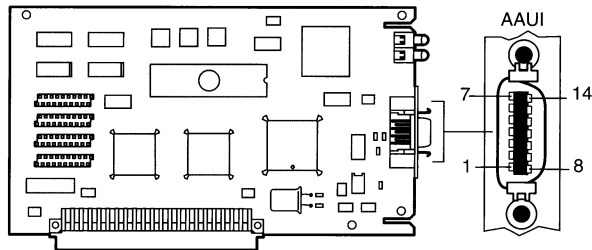

**Figure 5 Apple Ethernet NB Card**

---

## Apple Ethernet LC Card

The Apple Ethernet LC Card (Figure 6) has an Ethernet port that allows you to connect a Macintosh LC or LC II computer to an Ethernet network using the 802.3 IEEE standard.

With the addition of the appropriate Apple Ethernet Cable System media adapter, Ethernet LC Cards can connect to any standard Ethernet cabling environment: thin coax, thick coax, or unshielded twisted-pair.

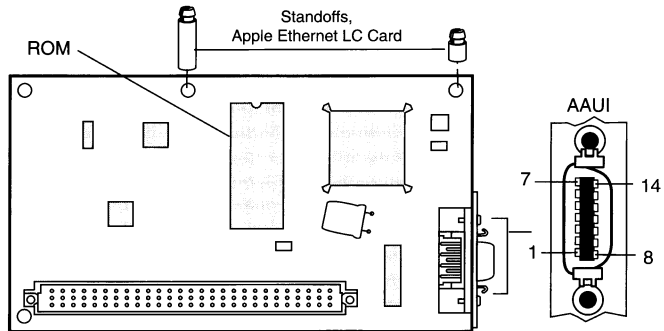

**Figure 6 Apple Ethernet LC Card**

There are currently two versions of the Apple Ethernet LC Card available. Older versions of the card are not compatible with the Macintosh LC II. If you want to use an older version Apple Ethernet LC Card with a Macintosh LC II, you must upgrade the ROM by using the ROM Upgrade Kit (P/N 922-0002).

Because both versions of the Apple Ethernet LC Card have the same Service part number (661-0621), use the following guidelines to distinguish between the two cards:

**New Apple Ethernet LC Card**

ROM P/N: 341-0470 (printed on the ROM)

**Old Apple Ethernet LC Card**

ROM P/N: 341-0842 (printed on the ROM)

---

## Apple Serial NB Card

The Apple Serial NB Card (Figure 7) is an intelligent NuBus card that allows you to connect Macintosh II family computers to synchronous modems and other remote systems via a variety of industry-standard serial communications protocols. The card includes up to four serial ports that support RS-232, RS-422, X.21, or V.35 communications.

The Serial NB Card has two cabling options: the Apple 4-Port RS-232 Cable, which has four DB-25 connectors that support RS-232 communications; and the V.35 cable, which has one DB-25 connector that supports RS-232 communications and one V.35 connector.

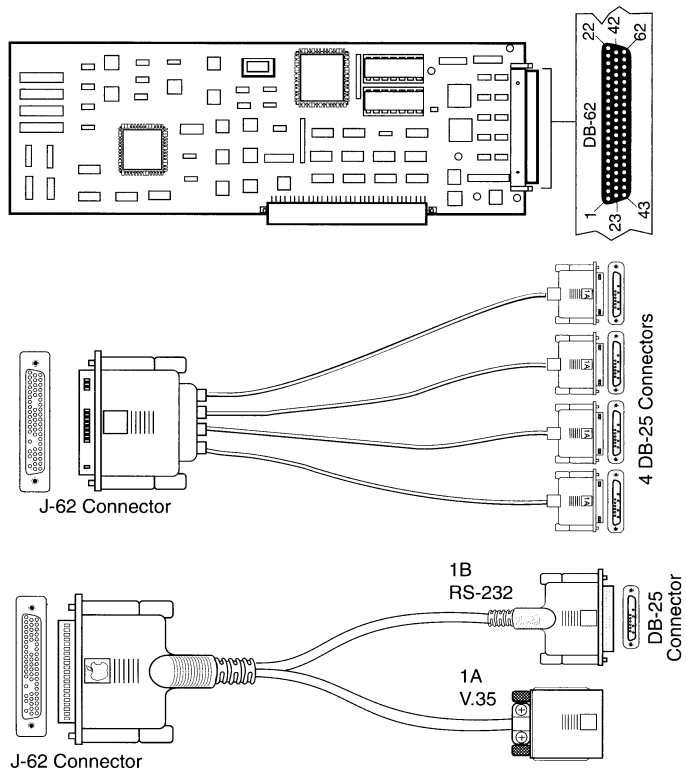

**Figure 7 Apple Serial NB Card and Cables**



---

## Apple Coax/Twinax Card

The Apple Coax/Twinax Card (Figure 8) is an intelligent NuBus card that allows you to connect Macintosh II family computers to an IBM SNA (Systems Network Architecture) network as 3270 Information Display Systems, using industry-standard coaxial cabling. With its own 68000 microprocessor, memory, and multitasking operating system, the Apple Coax/Twinax Card supports the execution of communications protocols with minimal access to the Macintosh II computer processor.

The SNA•ps 3270 application works with the Apple Coax/Twinax Card to allow single session Control Unit Terminal (CUT) emulation, or up to five-session Distributed Function Terminal (DFT) 3270 emulation.

The Apple Coax/Twinax Card has a twinax (15-pin D-style) connector in addition to the coax (BNC) connector for third-party 5250 terminal-emulation support.

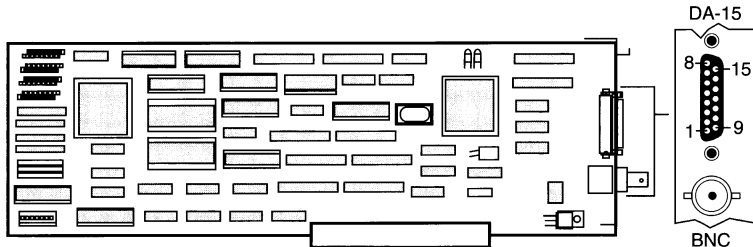

**Figure 8 Apple Coax/Twinax Card**

---

## Apple TokenTalk NB Card

The Apple TokenTalk NB Card (Figure 9) is an intelligent NuBus interface card that allows you to connect Macintosh II family computers to IBM and IBM-compatible Token Ring networks that operate at 4 megabits per second. When used with other Apple software products, the card supports a variety of network environments, including AppleTalk, IBM 3270 emulation, APPC, and SMB.

The Apple TokenTalk NB Card has a built-in 68000 microprocessor, 512K of RAM, and a multitasking operating system. The card operates independently of the Macintosh microprocessor, executing multiple networking protocols or network application programs concurrently.

The Apple TokenTalk NB Card is compatible with the IEEE 802.5 Media Access Control (MAC) standard for Token Ring networks, as well as the IEEE 802.2 Logical Link Control (LLC) standard for higher-level software access to 802.5 facilities.

The Apple TokenTalk NB Card has a single DE-9 port for connection to a Token Ring network. Use an IBM Token Ring Cable Type 1 or 3 to connect the Macintosh II to a Token Ring Multistation Access Unit (MAU). If you use an IBM Type 3 cable, you must first attach a cable noise filter to the port of the Apple TokenTalk NB Card.

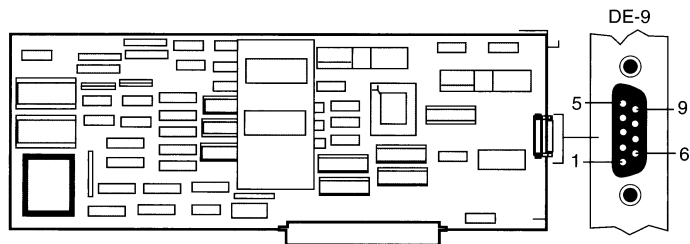

**Figure 9 Apple TokenTalk NB Card**

---

## Apple Token Ring 4/16 NB Card

The Apple Token Ring 4/16 NB Card (Figure 10) is an intelligent NuBus card that allows you to connect Macintosh II family computers to Token Ring networks that operate at either 4 or 16 megabits per second.

The Apple Token Ring 4/16 NB Card has a built-in 68000 microprocessor; 512K of RAM (expandable to 1 or 2.5 MB); and A/ROSE™ (a real-time multitasking operating system that runs on the card). The card operates independently of the main Macintosh microprocessor, executing multiple networking protocols or network application programs concurrently.

The Token Ring 4/16 NB Card uses the IBM Token Ring chip set, ensuring compatibility and interoperability with all IBM Token Ring networks that operate at 4 or 16 megabits per second. The card also supports a variety of software environments, including AppleTalk, SNA•ps 3270, and APPC.

**Important**    **The Token Ring 4/16 Card requires Macintosh system software version 6.0.5 or later.**

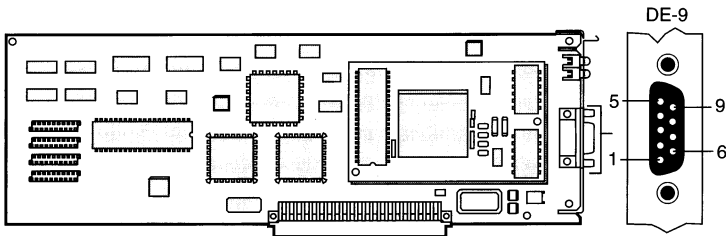

**Figure 10** Apple Token Ring 4/16 NB Card

---

## Apple ISDN NB Card

The Apple ISDN NB Card (Figure 11) is an intelligent NuBus card that allows you to connect Macintosh II family computers to an Integrated Services Digital Network (ISDN). When used with a compatible ISDN telecommunications application (purchased separately) and Apple ISDN software, the Apple ISDN NB Card allows you to send and receive voice and data communications anywhere in the world. ISDN applications provide a wide variety of services, such as a centralized image or document database, integrated screen-based telephony and office automation, and high-speed file transfer.

To use the Apple ISDN NB Card, you need the following items:

- A Macintosh II computer running system software version 7.0 (or later)
- Basic rate interface lines that support one of the following ISDN basic rate lines or equivalent:
  - AT&T 5ESS
  - Northern Telecom DMS-100
  - An emulator or PBX that is compatible with one of the above switches
- An RJ-45 cable
- A basic analog telephone with dual-tone multifrequency dialing
- A telephone cord to connect the telephone to the RJ-11 connector on the ISDN card
- A network terminating resistor (required if more than 33 feet of cable separates the network termination point and the Apple ISDN NB Card)
- A telecommunications application that works with ISDN
- Apple ISDN software installer disks
- An Apple ISDN power supply

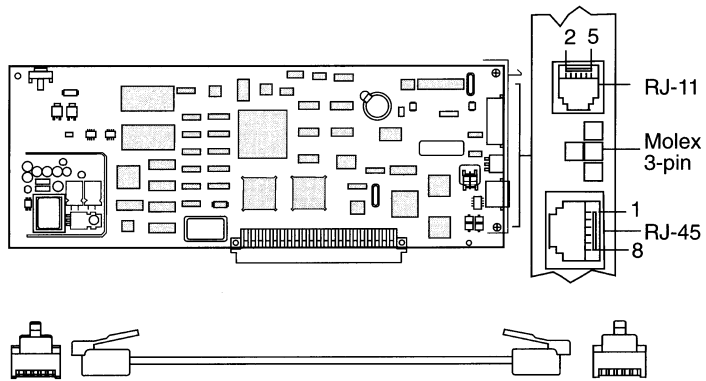
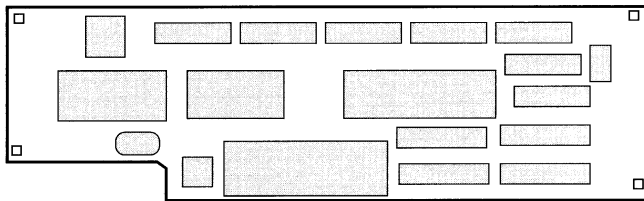

**Figure 11 Apple ISDN NB Card and RJ-45 Cable**

---

### **ImageWriter II/LQ LocalTalk Option Card**

The ImageWriter II/LQ LocalTalk Option Card (Figure 12) allows you to connect an ImageWriter II, II/L, or LQ printer to a LocalTalk network.



**Figure 12 ImageWriter II/LQ LocalTalk Option Card**

---

## Troubleshooting Interface Cards

Most interface card failures are resolved by checking the card installation and connections, verifying that required software is properly installed, or exchanging a defective interface card. To troubleshoot your interface card, perform the following troubleshooting steps for your specific interface card.

---

### Apple II Workstation Card

To troubleshoot the Apple II Workstation Card, perform the following corrective actions in the order listed:

1. Check the LocalTalk cables and connectors.
2. Make sure the cable is plugged into the proper port on the card.
3. Reseat the Apple II Workstation Card.
4. Reinstall the AppleShare IIfx Workstation software and configure the software to communicate with the serial port containing the Apple II Workstation Card.
5. Replace the Apple II Workstation Card.

---

### LocalTalk PC Card

To troubleshoot the LocalTalk PC Card, perform the following corrective actions in the order listed:

1. Check the LocalTalk cables and connectors.
2. Check the software configuration and installation. Make sure the software is configured to match the LocalTalk PC Card DIP switch settings.
3. Reseat the LocalTalk PC Card.
4. Verify the option switch settings on the card.
5. Check for duplicate I/O addresses, interrupt levels, or DMA channels when other peripherals are connected to the PC-compatible computer.
6. Replace the ROM on the card with revision C or higher.
7. Replace the LocalTalk PC Card.

---

### EtherTalk Interface and EtherTalk NB Cards

To troubleshoot the Apple EtherTalk Interface and EtherTalk NB Cards, perform the following corrective actions in the order listed:

1. Check the network cables, connectors, and termination.
2. Reseat the EtherTalk Interface or EtherTalk NB Card.

- 
3. Make sure that the jumper is configured for the appropriate connection, AUI or thin coax (DIX setting = AUI; BNC setting = thin coax).
  4. Reinstall the latest version of the EtherTalk software, which is available on the *Network Software Installer* (NSI) disk on AppleLink.
  5. Replace the EtherTalk Interface or EtherTalk NB Card.
  6. Move the EtherTalk card to a different CPU slot.

---

### **Apple Ethernet NB Card**

When you switch on the Macintosh computer, the Apple Ethernet NB Card executes a self-test diagnostic. Two small LEDs on the card indicate the results of the test. When you switch on the computer, both LEDs turn on. At the conclusion of the test, the red LED turns off and the green LED remains on, indicating that the card is functioning correctly. If the red LED remains on, the card may be incorrectly installed or damaged.

To troubleshoot the Apple Ethernet NB Card, perform the corrective actions in the order listed:

1. Check the network cables, connectors, and termination.
2. Reseat the Apple Ethernet NB Card.
3. Verify that the transceiver is functioning correctly. If you are using an Apple Ethernet Twisted-Pair Transceiver, observe the green LED on the transceiver. If the green LED is off, the transceiver is not functioning properly, not wired correctly, or not configured to the hub properly.
4. Reinstall the latest version of the EtherTalk software, which is available on the *Network Software Installer* (NSI) disk on AppleLink.
5. Replace the Apple Ethernet NB Card.

---

### **Apple Ethernet LC Card**

To troubleshoot the Apple Ethernet LC Card, perform the following corrective actions in the order listed:

1. Check the network cables, connectors, and termination.
2. Reseat the Apple Ethernet LC Card.
3. Verify that the transceiver is functioning correctly. If you are using an Apple Ethernet Twisted-Pair Transceiver,

- 
- observe the green LED on the transceiver. If the green LED is off, the transceiver is not functioning properly, not wired correctly, or not configured to the hub properly.
4. Reinstall the most current version of the EtherTalk software from the *Network Software Installer* (NSI) disk, which is available on AppleLink.
  5. If you are using an older version Apple Ethernet LC Card with a Macintosh LC II computer, upgrade the ROM on the card.
  6. Replace the Apple Ethernet LC Card.

---

### **Apple Serial NB Card**

When you switch on the Macintosh computer, the Apple Serial NB Card executes a self-test diagnostic. Two small LEDs on the card indicate the results of the test. When you switch on the computer, both LEDs turn on. At the conclusion of the test, the red LED turns off and the green LED remains on, indicating that the card is functioning correctly. If the red LED remains on, the card may be incorrectly installed or damaged.

To troubleshoot the Apple Serial NB Card, perform the following corrective actions in the order listed:

1. Check the cables and connectors.
2. Reseat the Apple Serial NB Card.
3. Verify that you installed the appropriate resistor packs on the card for the type of cable you are using.
4. Reinstall the networking and system software.
5. Reinstall the application software.
6. Replace the Apple Serial NB Card.

---

### **Apple Coax/Twinax Card**

When you switch on the Macintosh computer, the Apple Coax/Twinax Card executes a self-test diagnostic. Two small LEDs on the card indicate the results of the test. When you switch on the computer, both LEDs turn on. At the conclusion of the test, the red LED turns off and the green LED remains on, indicating that the card is functioning correctly. If the red LED remains on, the card may be incorrectly installed or damaged.



---

To troubleshoot the Apple Coax/Twinax Card, perform the following corrective actions in the order listed:

1. Check the cables and connectors.
2. Reseat the Apple Coax/Twinax Card.
3. Reinstall the networking and system software.
4. Reinstall the application software.
5. Replace the Apple Coax/Twinax Card.

---

### **Apple Token Ring 4/16 NB Card**

When you switch on the Macintosh computer, the Apple Token Ring 4/16 NB Card executes a self-test diagnostic. Two small LEDs on the card flicker while the card performs its self-test. At the conclusion of the test, the red LED turns off and the green LED remains on, indicating that the card is functioning correctly. If the red LED remains on, the card may be incorrectly installed or damaged.

To troubleshoot the Token Ring 4/16 NB Card, perform the following corrective actions in the order listed:

1. Check the network cables and connectors.
2. Reseat the Apple Token Ring 4/16 NB Card.
3. Reinstall the most current version of the TokenTalk software from the *Network Software Installer* (NSI) disk, which is available on AppleLink.
4. Replace the Apple Token Ring 4/16 NB Card.

---

### **Apple TokenTalk NB Card**

To troubleshoot a TokenTalk NB Card, perform the following corrective actions in the order listed:

1. Check the network cables and connectors.
2. Reseat the Apple TokenTalk NB Card.
3. Reinstall the latest version of the TokenTalk software from the *Network Software Installer* (NSI) disk, which is available on AppleLink.
4. Replace the Apple TokenTalk NB Card.

---

## Apple ISDN NB Card

When you switch on the Macintosh computer, the Apple ISDN NB Card executes a self-test diagnostic. Two small LEDs on the card indicate the results of the test. When you switch on the computer and the card receives power, the red LED turns on. As the self-test progresses, both LEDs turn on. At the conclusion of the test, the red LED turns off and the green LED remains on, indicating that the card is functioning correctly. If the red LED remains on, the card may be incorrectly installed or damaged.

To troubleshoot the Apple ISDN NB Card, perform the following corrective actions in the order listed:

1. Check cables and connectors.
2. Reseat the Apple ISDN NB Card.
3. Confirm that the Apple ISDN NB Card and MacISDN Config software are installed and functioning correctly:
  - a. Restart the Macintosh computer and launch the MacISDN™ Config software.
  - b. Choose **Open Active Configuration** from the File menu. If you see the correct switch settings displayed on the computer screen, the card and software are installed and functioning correctly.
4. Replace the Apple ISDN NB Card.

---

## ImageWriter II/LQ LocalTalk Option Card

To troubleshoot the ImageWriter II/LQ LocalTalk Option Card, perform the following corrective actions in the order listed:

1. Verify that the LocalTalk Option Card is installed and that the dip switches are set correctly.
2. Check the LocalTalk cables and connectors.
3. Reseat the ImageWriter II/LQ LocalTalk Option Card.
4. Replace the ImageWriter II/LQ LocalTalk Option Card.

## Interface Card Connectors and Cables

Use the following table to identify the appropriate peripheral cable or media adapter to use with each Apple interface card.

<b>Interface Card Connectors and Cables</b>				
<b>Interface Card</b>	<b>Cable Description</b>	<b>Cable Part Number</b>	<b>Cable Type</b>	<b>Network Type</b>
Token Ring 4/16 NB Card (661-1617)  TokenTalk NB Card (661-0460)	IBM Token Ring Cable Type 1 or 3	N/A	DE-9 to IBM MAU	Token Ring
Coax/Twinax Card (661-0458)	Twinax Cable, DA-15 or Coax Cable or Third-party cable	077-0104  077-0107	DA-15 to Twinax  BNC to BNC	IBM 3270
Serial NB Card (661-0517)	Apple 4-Port RS-232 Cable or Apple V.35 Cable	590-0690  590-0691	DB-62 to DB-25  DB-62 to V.35	RS-232/RS422  V.35/RS-232
ISDN NB Card (661-0620)	UTP RJ-45 Cable	590-0627	RJ-45 to RJ-45	ISDN
Ethernet NB Card (661-0619)  Ethernet LC Card (661-0621)	Apple AUI Adapter or  Thin Coax Transceiver or  Twisted-Pair Transceiver	630-8505  630-8504  630-8503	AAUI to DA-15 (AUI)  AAUI to RJ-45  AAUI to BNC	Ethernet
EtherTalk NB Card (661-0496)  EtherTalk Interface Card (661-0414)	Third-party cable	N/A	DA-15 to DA-15 (AUI)  BNC to BNC	Ethernet

\* All interface card connectors are female, except for the DA-15 connector on the Coax/Twinax Card.

## Apple LocalTalk Cable System

The Apple LocalTalk Cable System uses shielded, twisted-pair cable to connect up to 32 devices in a single network. You can connect networks to support more devices and longer distances. The LocalTalk Cable System is always arranged in a bus topology.

LocalTalk cable comes in preassembled kits and in custom wiring kits. A basic kit contains a 2-meter cable, a connector box that connects each device to the cable, and a cable extender. The basic kit is available in two versions: the LocalTalk Locking Connector Kit DIN-8 (Figure 13) and the LocalTalk Locking Connector Kit DE-9 (Figure 14). The custom wiring kit contains a roll of cable and the necessary plugs, cable splicers, and extenders that allow you to create custom-length cables.

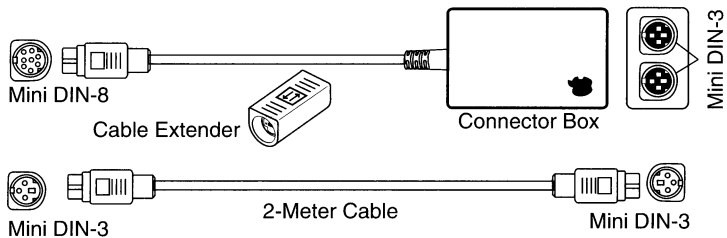

**Figure 13 LocalTalk Connector Kit DIN-8**

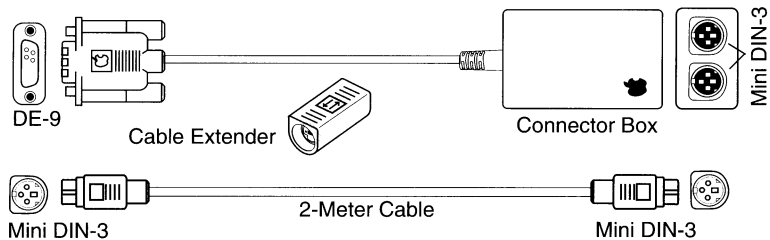

**Figure 14 LocalTalk Connector Kit DE-9**

---

Each LocalTalk connector box has a built-in resistor that terminates the network. For proper network termination, the connector at each end of a LocalTalk cable system network must have one empty outlet.

Each device sends information through the LocalTalk connector box, through both cables attached to the box, and out over the bus. It makes no difference where you place devices along the bus; you can place computers, servers, and peripherals wherever it makes most sense for your network.

The following table provides the specifications for Apple's LocalTalk cable.

<b>LocalTalk Cable Specifications</b>	
Conductors	22 AWG stranded, 17 ohms per 300 meters
Shield	85 percent coverage braid
Impedance	78 ohms nominal
Capacitance	68 picofards per meter nominal
Rise time	175 ns maximum, 0 to 50 percent at 300 meters
Diameter	4.7 mm (0.183 inches) maximum

Use the following table to identify the appropriate LocalTalk Connector or Cable Kit to use with each Macintosh computer, ImageWriter printer, or LaserWriter printer.

<b>LocalTalk Cable Kits</b>			
<b>Device</b>	<b>Cable/ Connector Kit</b>	<b>Contents</b>	<b>Part #</b>
Macintosh 128K, 512K, and 512K enhanced; LaserWriter and LaserWriter Plus	LocalTalk Locking Connector Kit, DB-9	1 LocalTalk connector with DE-9 plug; 2-meter cable; 1 cable-extender plug	630-8272
Apple IIe <sup>1</sup> , Apple IIgs; all other Macintosh computers; ImageWriter II <sup>2</sup> ; LaserWriter II NT, NTX, IIx, and IIg; Personal LaserWriter NT	LocalTalk Locking Connector Kit, DIN-8	1 LocalTalk connector with DIN-8 plug; 2-meter cable; 1 cable-extender plug	630-8275
General Use	LocalTalk Locking Cable Kit, 10 Meter	10-meter cable; cable extender	630-8273
	LocalTalk Locking Cable Kit, 25 Meter	25-meter cable; cable extender	630-8276
	LocalTalk Custom Wiring Kit	100-meter cable; assembled plugs; cable splicers; cable extenders	M2070
1 With Apple II Workstation Card and software 2 With ImageWriter II/LQ LocalTalk Option Card			

---

## Apple Ethernet Cable System

The Apple Ethernet Cable System is a family of products from Apple Computer that provides connectivity to Ethernet networks. All Apple Ethernet products conform to the IEEE 802.3 standard for Ethernet, so they can easily work with Ethernet products from other vendors.

Apple Ethernet media adapters allow you to connect to any standard Ethernet cable system through the Apple Ethernet port (AAUI port). This port is a universal connection point that is either built into your Apple device or provided through the installation of an interface card, such as the Apple Ethernet NB Card or Apple Ethernet LC Card.

---

### Apple Ethernet Thin Coax Transceiver

The Apple Ethernet Thin Coax Transceiver (Figure 15) connects computers and peripheral devices equipped with an Apple Ethernet port (AAUI port) to a thin coaxial cable Ethernet network. You simply connect the network cable to the transceiver and plug the transceiver into the Apple Ethernet port on the device.

The Apple Ethernet Thin Coax Transceiver kit consists of an external transceiver with an Apple Ethernet connector. The kit also includes a 2-meter length of self-terminating cable, which you can use to connect to another transceiver on the network. (You can also purchase cable in 5-meter and 13-meter lengths to connect devices over longer distances.)

Both the Apple Ethernet Thin Coax Transceiver and Apple Ethernet cable are self-terminating. This means that if a cable becomes disconnected for any reason, both halves of the network will remain functional (although the separated networks won't be able to communicate with one another until the cable is reconnected).

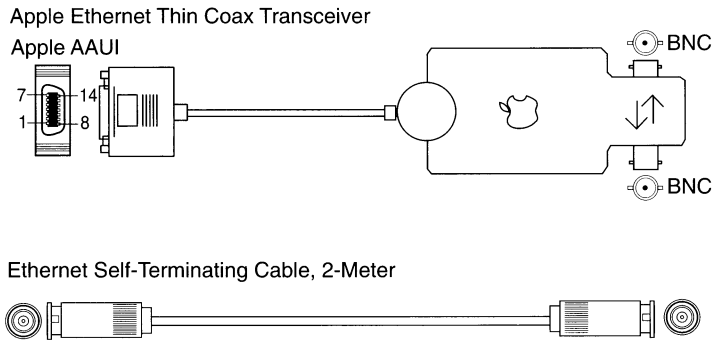

**Figure 15 Apple Ethernet Thin Coax Transceiver and Cable**

### Apple Ethernet Twisted-Pair Transceiver

The Apple Ethernet Twisted-Pair Transceiver (Figure 16) connects computers and peripheral devices equipped with an Apple Ethernet port (AAUI port) to a twisted-pair Ethernet network. The transceiver conforms to the IEEE 802.3 10BASE-T standard for implementing Ethernet over unshielded twisted-pair cable. It provides an RJ-45 (eight-pin) telephone-style connector jack for attaching the device to a network.

Ethernet cable systems that use unshielded twisted-pair cable are configured in an active-star topology. In an active-star topology, each workstation and peripheral connects directly to a central controlling hub that routes signals between the connected devices. Fully supporting the 10BASE-T standard, the Apple Ethernet Twisted-Pair Transceiver works with most third-party 10BASE-T hubs.

**Note**

If you connect the Ethernet Twisted-Pair Transceiver with a third-party hub that does not support Signal Quality Error (SQE) and the link integrity function, the link between the transceiver and the hub will not become active. To determine if the link between the transceiver and the hub is active, observe the green LED on the transceiver. If the green LED is on, the link is active; if the green LED is off, the link is not active.



---

**Important** Be sure to use the patch cord provided with the Apple Ethernet Twisted-Pair Transceiver Kit when you connect the transceiver to the network. Common telephone cable is not properly wired for a network connection.

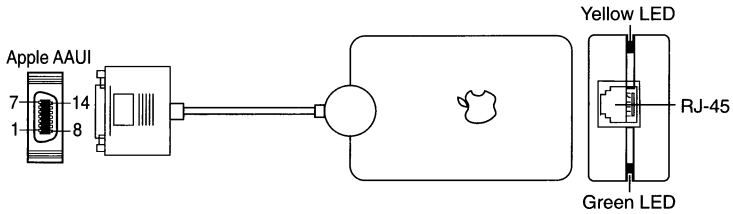

**Figure 16 Apple Ethernet Twisted-Pair Transceiver**

---

### Apple Ethernet AUI Adapter

The Apple Ethernet AUI Adapter (Figure 17) provides your network device with a standard Attachment Unit Interface (AUI). This adapter, which fully supports the IEEE 802.3 AUI specification, allows you to connect your Apple Ethernet device to external transceivers for fiber-optic, thick coax, and other Ethernet media types.

The Apple Ethernet AUI Adapter has three connectors: the 14-pin AAUI connector plugs into the computer's Ethernet port; the DA-15 connector connects the adapter to any standard external Ethernet transceiver; and the AC power cord attaches the adapter to an AC outlet. The Apple Ethernet AUI Adapter contains its own power supply.

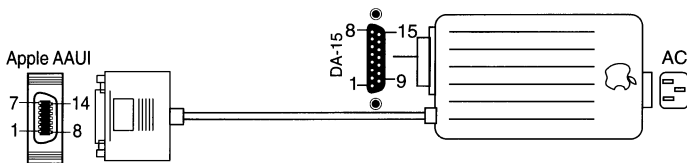

**Figure 17 Apple Ethernet AUI Adapter**

---

## Apple Ethernet Cable System Specifications

The following table shows the specifications for the Apple Ethernet Thin Coax Transceiver.

<b>Ethernet Thin Coax Transceiver</b>	
Topology	Serial bus
Connectors	Apple Ethernet 14-pin, 2 BNC posts
Wiring	Apple Ethernet self-terminating
Signaling standard	IEEE/ISO 802.3 10BASE-2
Signaling speed	10 Mbps
Frame format	As per 10BASE-2 standard
FCC certification	Class B

The following table shows the specifications for the Apple Ethernet AUI Adapter.

<b>Ethernet AUI Adapter</b>	
Topology	AUI to Apple Ethernet port converter
Connectors	DA-15 with latch, Apple Ethernet 14-pin, and IEC power
Wiring	2.5 meter Apple Ethernet port cable and 6 ft. power cord
Signaling standard	IEEE/ISO 802.3 AUI
Signaling speed	10 Mbps
Power supply voltage to AUI	12 volts nominal
Maximum attached MAU current draw	500 mA
Input voltage to IEC	100V to 240 VAC, 50 or 60 Hz

---

The following table shows the specifications for the Apple Ethernet Twisted-Pair Transceiver.

<b>Ethernet Twisted-Pair Transceiver</b>	
Topology	Star—requires 10BASE-T hub
Connectors	Apple Ethernet 14-pin, RJ-45 receptacle
Wiring	Unshielded twisted-pair (telephone style)
Signaling standard	IEEE/ISO 802.3 10BASE-T
Signaling speed	10 Mbps
Frame format	IEEE 802.3 standard (10BASE-T)
Network status	LEDs indicate link integrity and data activity
Self-correction	Automatic correction of receive wiring polarity errors

---

**Apple Modem 300/1200**

The Apple Modem 300/1200 is a standard asynchronous 300/1200-baud modem that allows Macintosh computers to communicate with other computers. The Apple Modem 300/1200 features automatic or manual telephone answering and dialing, tone and pulse-tone compatibility, and compatibility with communications software like *MacTerminal*<sup>®</sup>.

The tables below show the standard switch settings for the Modem 300/1200.

<b>Modem 300 – Switches</b>		
<b>Switch</b>	<b>Function</b>	<b>Setting</b>
<b>1</b>	Carrier Detect	ON: Always high (default setting) OFF: Normal
<b>2</b>	Not Used	
<b>3</b>	Data Terminal Ready	ON: Modem supplies OFF: Computer supplies (default)

<b>Modem 1200 – Switches</b>		
<b>Switch</b>	<b>Function</b>	<b>Setting</b>
<b>1</b>	Carrier Detect	ON: Always high (default setting) OFF: Normal
<b>2</b>	PBX/CBX	ON: Doesn't meet Bell Standard OFF: Meets Bell Standard - 212A (default)
<b>3</b>	Data Terminal Ready	ON: Modem supplies OFF: Computer supplies (default)

---

## **Apple Personal Modem**

The Apple Personal Modem is a compact, 300/1200-baud modem with the following features:

- Standard serial interface
- Automatic answer, dial, and redial
- Compatibility with communications software like *MacTerminal*
- Variable transmission speeds

The Apple Personal Modem has no DIP switches. The baud rate, parity, and duplex settings for the modem are software controlled. The Apple Personal Modem supports 110, 300, and 1200 baud rates.

---

## **Apple Data Modem 2400**

The Apple Data Modem 2400 is a standard asynchronous 2400-baud modem that allows Macintosh computers to communicate with other personal computers, minicomputers, and mainframes. The Apple Data Modem 2400 comes with a built-in error-correction feature called the Microcom Networking Protocol (MNP). MNP allows the Apple Data Modem 2400 to provide fast and accurate data transmission—even over noisy or low-quality telephone lines—when communicating with another MNP-compatible computer.

The Apple Data Modem 2400 can be used in two modes—active or pass-through. In the active mode, communication is established between the modem and the host computer. In pass-through mode, the modem is bypassed and the host computer communicates with the peripheral device attached to the pass-through connector. The pass-through connector is marked with a telephone handset (see Figure 18).

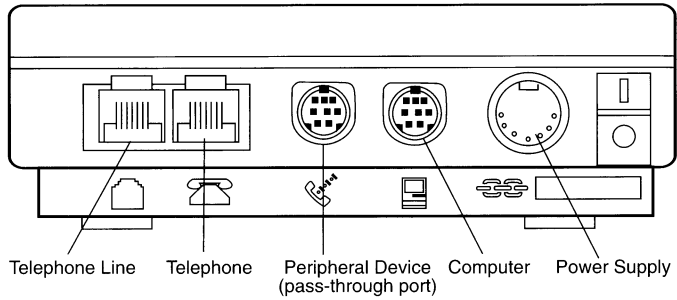
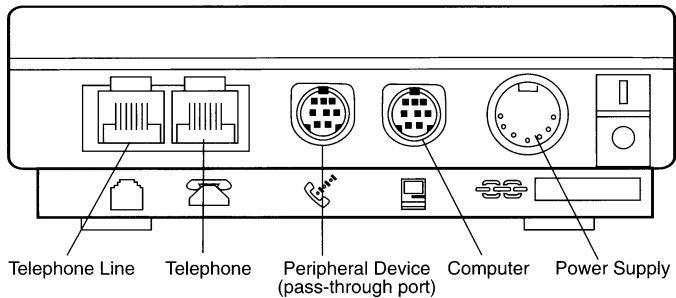

**Figure 18 Apple Data Modem 2400 Ports**

### AppleFAX Modem

The AppleFAX™ Modem allows Macintosh computers to send fax files to—and receive them from—any Group 3-compatible fax machine. In addition, the AppleFAX Modem allows you to exchange Macintosh data files with other AppleFAX Modem users at transmission speeds of 9600 bps.

The AppleFAX Modem operates in one of two modes—active or pass-through. In the active mode, communication goes between the modem and the host computer. In pass-through mode, the host computer bypasses the modem and communicates directly with the peripheral device attached to the pass-through connector. The pass-through connector is marked with a telephone handset (see Figure 19).



**Figure 19 AppleFAX Modem Ports**

---

### **Macintosh Portable Data Modem 2400 and Int'l XP 2400 Modem**

The Macintosh Portable Data Modem 2400 (United States and Canada) and the Int'l XP 2400 Modem (International) are standard asynchronous 2400-baud modems that allow Macintosh Portable computers to communicate with other personal computers, minicomputers, and mainframes. The Macintosh Portable Data Modem 2400 and the Int'l XP 2400 Modem can communicate with any standard data modem operating at 300, 1200, or 2400 bps.

---

### **Macintosh PowerBook Fax/Data Modem**

The Macintosh PowerBook Fax/Data Modem allows Macintosh PowerBook computers to communicate with other personal computers, minicomputers, and mainframes and to send fax transmissions at 9600 bps. This special, low-power modem fits inside the PowerBook 100, 140, 145, and 170, and can operate unattended.

---

## Troubleshooting Modems

Most modem problems are caused by improper installation and setup. Other problems are the result of incompatible transmission rates and data format settings or faulty telephone connections. To verify that your modem is properly connected to the computer and operating correctly, perform the following troubleshooting test sequence:

- For a Modem 300/1200, Personal Modem, Data Modem 2400, or AppleFax Modem, perform the power test, phone test, and computer test.
- For a Macintosh Portable or PowerBook modem, perform the phone test and the computer test only.

---

### Power Test

The sections that follow explain how to test the power on the modems indicated.

#### Apple Modem 300/1200

When you switch on your Apple Modem 300/1200, the green LED should light. If the green LED does not light:

1. Verify that the DIP switches on the back of the modem are properly configured.
2. Check that all cables are securely seated.
3. Verify that the modem power cable is properly connected to the modem and to the AC power outlet.
4. Replace the modem and repeat the power test.

#### Personal Modem

When you plug the Apple Personal Modem into an AC power outlet, you should hear a short beep. If you don't hear a beep:

1. Turn the volume control clockwise and replug the modem into the AC power outlet.
2. Check that all cables are securely seated.
3. Verify that the power connector on the modem is properly installed.
4. Replace the modem and repeat the power test.



---

## Data Modem 2400

The Apple Data Modem 2400 executes a self-test when you switch it on. If all tests pass, the yellow LED on the front panel flashes briefly, you hear two quick beeps, and the green LED lights.

1. **If the green LED does not light:**
  - a. Verify that the modem is plugged into the AC power outlet and the power switch is on.
  - b. Verify that the power connector is securely connected to the modem.
  - c. Replace the power connector with a known-good power connector and repeat the power test.
  - d. Replace the main logic board and repeat the power test.
2. **If the yellow and green LEDs flash alternately:**
  - Replace the main logic board and repeat the power test.
3. **If the yellow and green LEDs light, but you do not hear the modem beep twice:**
  - a. Adjust the volume control, verify that the speaker is connected, and repeat the power test.
  - b. Replace the speaker with a known-good speaker and repeat the power test.

## AppleFAX Modem

When you switch on the AppleFAX Modem, the green LED should light. If the green LED does not light:

1. Verify that the modem's power supply is properly connected to the modem and to the AC power outlet.
2. Check that all cables are securely seated.
3. Replace the power supply with a known-good power supply and repeat the power test.
4. Replace the modem and repeat the power test.
5. If the modem's green and yellow LEDs flash alternately, replace the modem and repeat the power test.

---

## Phone Test

The sections that follow explain how to test your phone connection for the modems indicated.

### **Personal Modem, Data Modem 2400, and AppleFAX Modem**

To verify that your Personal Modem, AppleFAX Modem, or Data Modem 2400 is properly connected to the telephone and the telephone line, lift the receiver off the telephone and listen.

1. **If you hear a dial tone:**
  - The modem is properly connected to the telephone line.
2. **If you don't hear a dial tone:**
  - a. Plug the telephone back into the wall jack.
  - b. Lift the receiver and listen. If you hear a dial tone, the phone line is working. The problem may be that the modem is incompatible with your telephone system. Check with your telephone service provider to make sure the modem can work with your telephone system.
3. **If you hear a dial tone on the telephone but not through the modem:**
  - a. Connect the telephone cable that came with the modem to the wall jack and to the telephone.
  - b. Lift the receiver off the telephone and listen. If there is no dial tone, replace the telephone cable.
  - c. If the modem still has no dial tone, verify that all cable connections are correct and secure.
  - d. If the modem still has no dial tone, replace the modem.

### **Macintosh Portable and PowerBook Modems**

To verify that your Macintosh Portable or PowerBook modem is properly installed and communicating with the phone line:

1. Switch on the modem and the Macintosh Portable or PowerBook computer.

- 
2. Choose **Control Panel** from the Apple ( ) menu and doubleclick the Portable icon.
    - a. If you can see the button labeled *Internal Modem* and it is selected, the modem card is installed correctly.
    - b. If you cannot see the Internal Modem button, switch off the computer and reinstall the modem card.
  3. Verify that the speaker volume is set above 0. This allows you to hear a dial tone and to hear the modem dial telephone numbers.
  4. Install *MacTerminal* or other communications software.
  5. Confirm that the software is correctly configured to communicate with the modem (e.g. baud rate, parity, stop bits). To confirm the correct setting, refer to the user manual for the application.
  6. Enter terminal mode. Type ATD and press <Return> (or choose the Dial command of your application software).
    - a. **If you can hear a dial tone:**
      - The modem is properly connected to the telephone line.
    - b. **If you don't hear a dial tone:**
      1. Plug the telephone back into the wall jack.
      2. Lift the receiver off the telephone and listen. If there is a dial tone, it means the telephone is working and the problem is with the telephone cable.
    - c. **If you hear a dial tone on your telephone but not through your modem:**
      1. Connect the telephone cable that came with your modem to the wall jack and to the telephone.
      2. Lift the receiver off the telephone and listen. If there is no dial tone, replace the telephone cable.
      3. If the modem still has no dial tone, verify that all cable connections are correct and secure.
      4. Lift the receiver off the telephone and listen. If you cannot hear a dial tone, replace the modem card.

---

## Computer Test

To verify that your modem is communicating with your Macintosh computer:

1. Switch on the modem and the Macintosh computer.
2. Install *MacTerminal* or other communications software.
3. Confirm that the software is correctly configured to communicate with the modem (e.g. baud rate, parity, stop bits). To confirm the correct setting, refer to the user manual for the application.
4. Enter terminal mode. Type AT and press <Return>. If everything is connected properly, the screen displays: **OK**. If you type AT and press <Return> a few times and don't get an **OK** response:
  - a. Verify that the software transmission speed is set correctly for your modem (300, 1200, 2400, etc.).
  - b. Check that all cables are securely seated.
  - c. Reset the modem's operating parameters. To return the modem to factory setting, type AT&F and press <Return>.
  - d. Switch off the computer, unplug the modem, and remove the modem data cable. Check for bent pins at the cable ends. If necessary, replace the modem data cable.
  - e. Plug in the modem and switch on the Macintosh computer.
  - f. Boot the communications software and enter terminal mode.
  - g. Type AT and press <Return>. If you still do not get an **OK** response, replace the modem.

---

## Modem Specifications

The following table shows the specifications for the Apple Modem 300/1200.

<b>Apple Modem 300/1200</b>	
Transmission speeds	Modem 300: 0 to 300 bps Modem 1200: 0 to 300 bps in low-speed mode; 1200 bps in high-speed mode
Data format	Protocol: Asynchronous Character length: 7 or 8 data bits; 1 or 2 stop bits Parity: Odd, even, mark, space, or none Mode: Full or half duplex
Modulation and compatibility	<b>Modem 300:</b> Bell 103-series per Bell System Technical Reference 41214—less synchronous mode.  <b>Modem 1200:</b> Bell 212A per Bell System Technical Reference 41214—less synchronous mode.
Operating modes	Answering: auto or manual Dialing: auto or manual; tone or pulse
Receiver sensitivity	0 to -45 dB full duplex
Interface	RS-232 using a DE-9 connector
Transmitter level	-10 dBm , fixed, as per FCC Part 68
Connectors	One power, one DE-9 data, and two modular telephone jacks

---

The following table shows the specifications for the Apple Personal Modem.

<b>Apple Personal Modem</b>	
Data format	Protocol: Asynchronous Character length: 7 or 8 data bits; 1 or 2 stop bits Parity: Odd, even, mark, space, or none Mode: Full-duplex
Transmission speeds	High: 1200 baud Low: 0 to 300 baud
Interface	Type: RS-232 compatible Connector: Mini-circular 8-pin
Operating modes	Auto or manual dial (including redial) Auto or manual answer
Receiver sensitivity	-10 to -45 dBm
Transmitter level	-10 dBm, fixed, as per FCC Part 68
Line monitoring	Audible (volume is adjustable) Visual (prints status messages on computer screen)
Connectors	Two RJ-11 modular telephone jacks (one for phone line cable; one for optional telephone) One mini-circular 8-pin jack (for data cable) Detachable head with AC plug

The following table shows the specifications for the Apple Data Modem 2400.

<b>Apple Data Modem 2400</b>	
Communication standards	300 bps Bell 103 1200 bps Bell 212A 1200 bps CCITT V.22A/B 2400 bps CCITT V.22bis
Error control	MNP Classes 1-4
Transmission speeds	2400 bps, 1200 bps, 300 bps
Dialing capability	Tone/pulse (dial)
Maximum serial speed	9600 bps (modem to computer)
Standard serial interface	RS-422-A compatible, with mini DIN-8 connector
Data format	Protocol: Serial binary, asynchronous Character length: 7 or 8 data bits; 1 or 2 stop bits Parity: Odd, even, or no parity Mode: Full duplex
Command set	Supports extended Hayes AT command set with Microcom standard commands for controlling and customizing MNP
Receiver dynamic range	-10 dBm to -42 dBm full duplex
Transmitter level	-10 dBm +1 dBm, fixed
Registration/certification	FCC Parts 68 and 15J Canadian DOC
Frequency tolerance	+7 Hz
Bit error rate	Less than 1 in $10^6$ on a 3002A line (unconditional line) channel specifications
Operating modes	Auto or manual dial Auto or manual answer
Line monitoring	Internal speaker with external volume control provided for monitoring call progress

The following table shows the specifications for the AppleFax Modem.

<b>AppleFax Modem</b>	
General	Microprocessor: 65C112 Timing: 1.8432 MHz ROM: 32k by 8 RAM : 8K by 8 Modem type: R96 fax-compatible chip set
Data format	Protocol: Asynchronous Compatible with Group 3 fax machines Character length: 7 or 8 bits; 1 or 2 stop bits Parity: Odd, even, or none Mode: Full duplex (data); half duplex (fax)
Transmission speeds	9600 bps 7200 bps 4800 bps 2400 bps (V.29 and V.27 ter)
Interface	Connector: Mini-circular 8-pin
Operating modes	Auto or manual dial Auto or manual answer
Receiver sensitivity	-10 to -40 dBm
Transmitter level	-10 dBm, fixed, as per FCC Part 68
Line monitoring	Audible (volume is adjustable) Visual (prints status messages on computer)
Connectors	Two RJ-11 modular telephone jacks (one for phone line cable; one for optional telephone) Two mini-circular 8-pin jacks (data cable and pass-through device)



The following table shows the specifications for the Macintosh Portable Data Modem 2400.

<b>Macintosh Portable Data Modem 2400</b>	
Communication standards	300 bps Bell 103 1200 bps Bell 212A 1200 bps CCITT V.22 2400 bps CCITT V.22bis
Transmission speeds	2400 bps, 1200 bps, 300 bps
Dialing capability	Tone/pulse (dial)
Data format	Protocol: Serial binary, asynchronous Character length: 7 data bits, 1 parity bit, 1 stop bit; 7 data bits, no parity, 2 stop bits; 8 data bits, no parity, 1 stop bit Parity: Odd, even, mark, space, no parity Mode: Full duplex
Command set	Supports a subset of the AT command set
Receiver dynamic range	-10 dBm to -43 dBm full duplex
Transmitter level	-10 dBm ( $\pm$ 1 dBm)
Automatic adaptive equalization on receiver channel	3 dBm improvement on SNR
Registration/certification	FCC Parts 68 and 15J Canadian DOC
Frequency tolerance	+7 Hz
Operating modes	Auto dial Auto or manual answer

The following table shows the specifications for the Macintosh PowerBook Fax/Data Modem.

<b>Macintosh PowerBook Fax/Data Modem</b>	
Fax compatibility	Group 3
Data communication standards	110 to 300 bps    Bell 103 110 to 300 bps    CCITT V.21 1200 bps            Bell 212A 1200 bps            CCITT V.22 2400 bps            CCITT V.22bis
Fax communication standards	2400 to 4800 bps    CCITT V.27ter 7200 to 9600 bps    CCITT V.29
Error control	MNP Class 4 CCITT V.42
Data compression	MNP Class 5 CCITT V.42bis
Transmission speeds	2400 bps, 1200 bps, 300 bps
Dialing capability	Tone/pulse dialing
Operating modes	Auto or manual dial Auto or manual answer
Data format	Protocol: Serial, binary, asynchronous Character length: 7 data bits, 1 parity bit, 1 stop bit; 7 data bits, no parity, 2 stop bits; 8 data bits, no parity, 1 stop bit Parity: Odd, even, mark, space, or no parity
Data transmission mode	Full duplex Asynchronous
Fax transmission mode	Half duplex
Command set	Extended Hayes AT command set

## Pinouts

This section includes pinout tables for all Apple networking cards and modems.

### Coax/Twinax Interface Card – Twinax Connector

Pin	Signal Description	Pin	Signal Description
1	No connection	9	No connection
2	No connection	10	No connection
3	No connection	11	No connection
4	No connection	12	No connection
5	No connection	13	No connection
6	No connection	14	"B" twinax signal
7	"A" twinax signal	15	No connection
8	No connection		

Connector type: DA-15 male

### Coax/Twinax and EtherTalk NB Interface Cards – Coax Connector

Pin	Signal Name	Signal Description
(Tip)	CX+	Transmit/receive data
(Sleeve)	CX-	Signal ground

Connector type: BNC male

### EtherTalk Interface and EtherTalk NB Cards

Pin	Signal Description	Pin	Signal Description
1	Shield	9	Collision presence -
2	Collision presence +	10	Transmit -
3	Transmit +	11	Reserved
4	Reserved	12	Receive -
5	Receive +	13	Power
6	Power return	14	Reserved
7	Reserved	15	Reserved
8	Reserved		

Connector type: DA-15 male

This connector supports thick coaxial cable with the use of an optional transceiver (not available from Apple).

**CAUTION:** The signals on this connector are not the same as on the DA-15 of the Apple IIc, II GS, III, III Plus, or Macintosh II video cards. DO NOT connect an Apple IIc, II GS, III, III Plus, or Macintosh II video card or cable to the EtherTalk Interface Card.

### TokenTalk NB and Token Ring 4/16 NB Cards

Pin	Signal Description	Pin	Signal Description
1	Receive data	6	Receive data
2	No connection	7	No connection
3	No connection	8	No connection
4	No connection	9	Transmit data
5	Transmit data		

Connector type: DE-9 male

### Ethernet NB and Ethernet LC Cards

Pin	Signal Name	Signal Description
1	FN Pwr	+12 volts @ 175 mA or +5 volts @ 420 mA
2	DI-A	Data In circuit A
3	DI-B	Data In circuit B
4	VCC	Voltage common
5	CI-A	Control In circuit A
6	CI-B	Control In circuit B
7	+5V	+5 volts (from host)
8	+5V	Secondary +5 volts (from host)
9	DO-A	Data Out circuit A
10	DO-B	Data Out circuit B
11	VCC	Secondary voltage common
12	NC	Reserved
13	NC	Reserved
14	FN Pwr	Secondary +12 volts or +5 volts
Shell	Protective Gnd	Protective ground

Connector type: AAUI male

---

### Serial NB Interface Card (Pins 1-20)

Pin	Signal Name	Signal Description
1	+CA1F	X.21 control, +CHA1, output
2	232TXDA1	Transmit data, CHA1, RS-232, output
3	-CA1F	X.21 control, -CHA1, output
4	1RTSA	Ready To Send, CHA1, RS-232, output
5	1CTSA	Clear To Send, CHA1, RS-232, input
6	+CB1F	X.21 control, +CHB1, output
7	232TXDB1	Transmit data, CHB1, RS-232, output
8	-CB1F	X.21 control, -CHB1, output
9	1RTSB	Ready To Send, CHB1, RS-232, output
10	1CTSB	Clear To Send, CHB1, RS-232, input
11	+IB1	X.21 indication, +CHB1, input
12	232TXDA2	Transmit data, CHA2, RS-232, output
13	2RXDA	Receive data, CHA2, RS-232, input
14	2RTSA	Ready To Send, CHA2, RS-232, output
15	2CTSA	Clear To Send, CHA2, RS-232, input
16	+IA1	X.21 indication, +CHA1, input
17	232TXDB2	Transmit data, CHB2, RS-232, output
18	2RXDB	Receive data, CHB2, RS-232, input
19	2RTSB	Ready To Send, CHB2, RS-232, output
20	2CTSB	Clear To Send, CHB2, RS-232, input

### Serial NB Interface Card (Pins 21-40)

Pin	Signal Name	Signal Description
21	+422TXCA1	+Transmit clock, CHA1, RS-422, input
22	-422TXCA1	-Transmit clock, CHA1, RS-422, input
23	+422RXDA1	+Receive data, CHA1, RS-422, input
24	-422RXDA1	-Receive data, CHA1, RS-422, input
25	+422RXCA1	+Receive clock, CHA1, RS-422, input
26	-422RXCA1	-Receive clock, CHA1, RS-422, input
27	+422TXDA1	+Transmit data, CHA1, RS-422, output
28	-422TXDA1	-Transmit data, CHA1, RS-422, output
29	+422TXCB1	+Transmit clock, CHB1, RS-422, input
30	-422TXCB1	-Transmit clock, CHB1, RS-422, input
31	+422RXDB1	+Receive data, CHB1, RS-422, input
32	-422RXDB1	-Receive data, CHB1, RS-422, input
33	+422RXCB1	+Receive clock, CHB1, RS-422, input
34	-422RXCB1	-Receive clock, CHB1, RS-422, input
35	+422TXDB1	+Transmit data, CHB1, RS-422, output
36	-422TXDB1	-Transmit data, CHB1, RS-422, output
37	GND_6	Extra ground
38	2TXCA	Transmit clock, CHA2, RS-232, input
39	2RXCA	Receive clock, CHA2, RS-232, input
40	2RXCB	Receive clock, CHB2, RS-232, input

### Serial NB Interface Card (Pins 41-62)

Pin	Signal Name	Signal Description
41	GND_5	Extra ground
42	2TXCB	Transmit clock, CHB2, RS-232, input
43	1DSRA	Data Set Ready, CHA1, RS-232, input
44	1DCDA/-IA1	Data Carrier Detect, RS-232/X.21 indication, -CHA1, input
45	1DTRA	Data Terminal Ready, CHA1, RS-232, output
46	1RIA	Ring Indicator, CHA1, RS-232, input
47	GND_4	CHB2 ground
48	1DSRB	Data Set Ready, CHB1, RS-232, input
49	1DCDB/-IB1	Data Carrier Detect, RS-232/X.21 indication, -CHB1, input
50	1DTRB	Data Terminal Ready, CHB1, RS-232, output
51	1RIB	Ring Indicator, CHB1, RS-232, input
52	GND_3	CHA2 ground
53	2DSRA	Data Set Ready, CHA2, RS-232, input
54	2DCDA	Data Carrier Detect, CHA2, RS-232, input
55	2DTRA	Data Terminal Ready, CHA2, RS-232, output
56	2RIA	Ring Indicator, CHA2, RS-232, input
57	GND_2	CHB1 ground
58	2DSRB	Data Set Ready, CHB2, RS-232, input
59	2DCDB	Data Carrier Detect, CHB2, RS-232, input
60	2DTRB	Data Terminal Ready, CHB2, RS-232, output
61	2RIB	Ring Indicator, CHB2, RS-232, input
62	GND_1	CHA1 ground

Connector type: DB-62 male



---

### Apple ISDN NB Card

Pin	Signal Name	Signal Description
1	NC	No connection
2	NC	No connection
3	TX1	Transmit 1
4	RX1	Receive 1
5	RX2	Receive 2
6	TX2	Transmit 2
7	VINF	Power in
8	+VINF	Power in

Connector type: RJ-45 male

### Apple ISDN NB Card

Pin	Signal Name	Signal Description
1	GND	Ground
2	+40 V	+40 volts DC
3	NC	No connection

Connector type: 3-pin Molex

---

### Modem 300/1200

Pin	Signal Name	Signal Description
2	DSR	Data Set Ready
3	SGND	Signal Ground
5	RCD	Receive Data
6	DTR	Data Terminal Ready
7	DCD	Data Carrier Detect
8	GND	Chassis ground
9	TXD	Transmit Data

Connector type: DB-9 male

### Apple Personal Modem

Pin	Signal Name	Signal Description
1	DSR	Data Set Ready (output)
2	DTR	Data Terminal Ready (input)
3	RXD	Receive Data (output)
4	SG	Signal Ground
5	TXD	Transmit Data (input)
6	SG	Signal Ground
7	DCD	Data Carrier Detect (output)
8	NC	No connection

Connector type: Mini DIN-8 male  
This interface is RS-232 compatible.

---

### AppleFax Modem and Apple Data Modem 2400

Pin	Signal Name	Signal Description
1	HSKo	Handshake (output)
2	HSKi	Handshake (input)
3	TxD-	Transmit data - (output)
4	SG	Signal Ground
5	RxD-	Receive data - (input)
6	TxD+	Transmit data + (output)
7	GPI	Carrier Detect (output)
8	RxD+	Receive data + (input)

Connector type: Mini DIN-8 male

---

### Macintosh Portable Data Modem

Pin	Signal Name	Signal Description
1	MODEM.PWR	Modem Power (output)
2	GND	Ground
3	RTS	Request To Send (output)
4	DCD	Data Carrier Detect (input)
5	RxD	Data Received (input)
6	CTS	Clear To Send (input)
7	MODEM.SOUND	Analog Sound (output)
8	TxD	Transmit Data (output)
9	RI.EXT	Ring Detect Interrupt (input)
10	-5 VDC	-5 volts DC
11	+5 VDC	+ 5 volts DC
12	DTR	Data Terminal Ready (output)
13	V1	Volume Control Bit (output)
14	V3	Volume Control Bit (output)
15	V2	Volume Control Bit (output)
16	MODEM.INS	Modem Installed (input)
17	MODEM/BUSY	Modem Busy (input)
18	MS.ENABLE	Modem Sound Enable (input)

Connector type: 18-pin, dual in-line socket connector

---

### Macintosh PowerBook Fax/ Data Modem

Pin	Signal Name	Signal Description
1	NC	
2	MODEM.PWR	Modem Power (input)
3	GND	Ground
4	MODEM/BUSY	Modem Busy (output)
5	US5V	+ 5 volts DC Power
6	RxD	Receive Data (output)
7	RI.DETECT	Ring Detect (output)
8	TxD	Transmit Data (input)
9	MODEM.SOUND	Modem Sound Output (output)
10	DTR	Data Terminal Ready (input)
11	MS.ENABLE	Modem Sound Enable (output)
12	RTS	Request To Send (input)
13	RESET	Reset (input)
14	CTS	Clear To Send (output)
15	MODEM.INS	Modem Inserted (output)
16	GND	Ground
17	GND	Ground
18	MODEM.5V	+5 volts DC
19	DCD	Data Carrier Detect (output)
20	MODEM.5V	+5 volts DC

Connector type: 20-pin, dual in-line socket connector

---

## Parts List

---

### Apple Data Modem 2400

Bottom case .....	630-5506
Light pipe, assembly.....	630-5505
Main logic board .....	661-0516
Power supply.....	600-0455
RJ-11 cable .....	590-0590
Screw, M 3 x .5 x 6 .....	462-3100
Speaker .....	600-0403
Top case.....	815-5073
Volume lever .....	815-5076

---

### Apple Modem 300/1200

Bottom cover .....	815-0791
Cable assembly, Apple IIGS peripheral adapter.....	590-0550
Cable assembly, interface (II, III, Lisa/Mac XL).....	590-0121
Cable assembly, interface (IIC) .....	590-0192
Cable assembly, interface (Macintosh).....	590-0197
Cable assembly, Macintosh Plus peripheral adapter ...	590-0553
Cable assembly, RJ-11 .....	076-8075
PCB, Modem 300 .....	661-75165
PCB, Modem 1200 .....	661-75164
PCB, Modem 1200, w/CSA .....	661-0293
Rubber foot.....	865-0003
Top cover.....	815-0790
Transformer, cable assembly .....	076-8077

---

### Apple Personal Modem

Cable, APM to Apple II, II+, IIe, Apple III, Mac XL ....	590-0555
Cable, APM/IW II to Apple IIc, smoke .....	590-0554
Cable, APM/IW II to Macintosh, smoke.....	590-0551
Cable, APM/IW II to Macintosh Plus, smoke.....	590-0552
Cable assembly, RJ-11 .....	076-8075
Main body, (includes power connector).....	661-0313
Plug head, power connector .....	933-0001

---

### AppleFax Modem

Auxiliary logic board.....	661-0435
Bottom case .....	630-5412
Light pipe assembly.....	630-5425
Main logic board .....	661-0433
Power supply.....	699-0130

---

RJ-11 cable .....	076-8075
ROM .....	342-0387
Screw, M 3 x .5 x 6 .....	462-3100
Speaker .....	600-0403
Top case.....	630-5413
Volume lever .....	815-5042

---

### **LocalTalk Cables**

LocalTalk locking cable kit, 10 meter .....	630-8273
LocalTalk locking cable kit, 25 meter .....	630-8276
LocalTalk locking connector kit, DB-9.....	630-8272
LocalTalk locking connector kit, DIN-8 .....	630-8275

---

### **Macintosh Portable Data Modem 2400 and Int'l XP 2400 Modem**

International XP 2400 Internal Modem* .....	661-0465
Int'l XP 2400 Internal Modem, Germany* .....	D661-0465
Macintosh Portable Data Modem 2400 .....	661-0468
MNP board, International XP 2400 Modem* .....	661-0588
Telephone cable, U.S. ....	590-0590

---

### **Macintosh PowerBook Fax/Data Modem**

DAA, Australia* .....	X077-0276
DAA, Denmark* .....	DK077-0276
DAA, Finland* .....	K077-0276
DAA, France* .....	F077-0276
DAA, Germany* .....	D077-0276
DAA, Ireland* .....	ER077-0276
DAA, Italy* .....	T077-0276
DAA, Netherlands* .....	N077-0276
DAA, Spain* .....	Y077-0276
DAA, Sweden* .....	S077-0276
DAA, Swiss-French* .....	SF077-0276
DAA, Swiss-German* .....	SD077-0276
DAA, Swiss-Italian* .....	ST077-0276
DAA, United Kingdom* .....	B077-0276
Internal modem board, 2400 baud, domestic.....	661-1621
Internal modem board, 2400 baud, international*.....	661-1620
Modem port cover.....	815-0578

\* These items are not available in the United States.

---

## Networking Interface Cards and Cables

Apple II Workstation Card.....	661-0389
Apple Coax/Twinax Card .....	661-0458
Cable, Twinax with DA-15 connector .....	077-0104
Coax cable .....	077-0107
Twinax T-connector .....	077-0105
Twinax terminator .....	077-0106
Apple Ethernet AUI Adapter.....	630-8505
Apple Ethernet LC Card .....	661-0621
Ethernet LC Card standoffs .....	076-0543
Apple Ethernet NB Card .....	661-0619
Apple Ethernet Thin Coax Transceiver .....	630-8503
Ethernet Self-Terminating Cable, 2-meter .....	076-0540
Ethernet Self-Terminating Cable, 5-meter .....	076-0541
Ethernet Self-Terminating Cable, 13-meter .....	076-0542
Apple Ethernet Twisted-Pair Transceiver.....	630-8504
UTP RJ45 cable (100 ohms) .....	590-0627
Apple ISDN NB Card.....	661-0620
Apple Serial NB Card .....	661-0517
256K DRAM IC.....	334-4256
Apple 4-Port RS232 cable.....	590-0690
Apple V.35 cable .....	590-0691
Apple Token Ring 4/16 NB Card .....	661-1617
Apple TokenTalk NB Card (replaced by 661-1617) ...	661-0460
Token Ring adapter cable .....	077-0109
EtherTalk Interface Card .....	661-0414
EtherTalk NB Card .....	661-0496
LocalTalk PC Card .....	661-0356
ROM, LocalTalk PC Card.....	342-0007



# Apple Networking Software

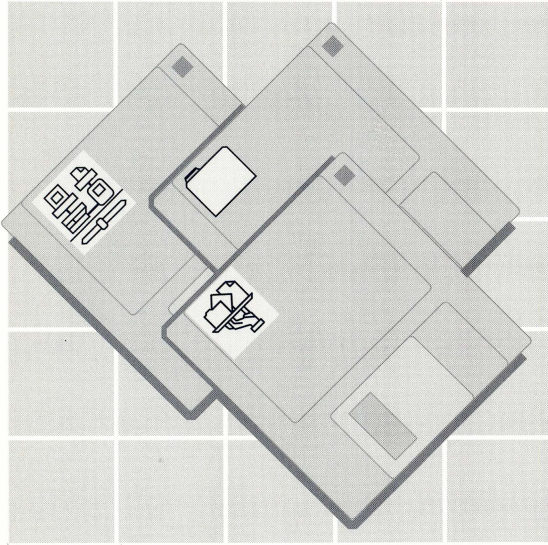

---

AppleShare 3.0	106
AppleTalk Internet Router 2.0	109
System 7	120
AppleTalk Remote Access 1.0	126
Network Interface Software	130
Connectivity Software	131
InterPoll Network Administrator's Utility	134

---

## AppleShare 3.0

AppleShare Server 3.0 is file and print server software that lets AppleTalk network users share information and easily access network printers. AppleShare 3.0 requires System 7 software, but supports System 6 and System 7 clients. System 7.1 requires AppleShare 3.0.1.

### Note

You can use one computer as your print and file server, but you should not use the same computer as your router.

---

### AppleShare Print Server

By using a dedicated Macintosh computer with one or more hard drives and AppleShare software, you can set up a print server, or spooler, that supports up to five printers in the same or different AppleTalk zones. Macintosh, Apple II, or MS-DOS computer users can share these printers. The Apple Printer Access Protocol (PAP) allows devices on a network to find and share printers.

AppleShare Print Server software allows users to simultaneously send documents to a printer. The software's server-based architecture provides administration and print control from a single location. The print server receives files and stores them when the printer is busy, thereby freeing the user's computer for other tasks.

AppleShare 3.0 software works with any printer on the AppleTalk system, including the Apple LaserWriter, Apple LaserWriter Plus, Apple LaserWriter II family, Varityper, and Linotronic L300 printers.

AppleShare software emulates a LaserWriter printer. MS-DOS computers that are able to print to LaserWriter printers (e.g., MS-DOS computers that have the LocalTalk PC Card) can likewise print to any AppleShare Print Server.

---

### AppleShare File Server

By using a dedicated Macintosh computer with at least 4 MB of RAM, System 7.0 (or later), and AppleShare software, you can set up an AppleTalk file server. Using the Macintosh Finder and Chooser, users can extend their reach across the network to share all network files and applications that reside on the file server's hard drive.

---

The following table shows Apple File Server requirements.

<b>File Server Requirements</b>		
<b>Usage Level</b>	<b>Concurrent Users</b>	<b>Minimum Configuration</b>
Light to moderate <sup>1</sup>	Up to 10	Mac Classic or SE/30 with 2 MB RAM and 40 MB hard disk
	Up to 30	Mac SE/30 with 4 MB RAM and 80 MB hard disk
	Up to 50	Mac II <sup>2</sup> with 4 MB RAM and 100+ MB hard disk
	Over 50	Requires 2 servers
Heavy <sup>3</sup>	Up to 20	Mac II with 4 MB RAM and 80 MB hard disk
	Up to 35	Mac II with 4 MB RAM and 100+ MB hard disk
	Over 35	Mac II with 4 MB RAM and 160+ MB hard disk—or use 2 servers

1 Assumes the server will mainly store small applications (or few large applications) and text files.  
2 Macintosh II family of computers.  
3 Assumes the server will store many space-intensive applications and files, such as large spreadsheets, graphics, and multiuser databases.

AppleShare 3.0 File Server software provides file storage for up to 120 concurrent users when the server is a Macintosh II (or later) computer. Users must log onto the file server; the speed at which they can access files is limited by the speed of the network and the server.

AppleShare management features include: monitoring and controlling server usage; displaying server status messages, which are useful in diagnosing problems; and creating detailed administrative reports. You can set up the file server with no restrictions and let everyone log on as a guest, or

---

you can assign access privileges. One way to assign privileges is to first assign users to groups and then assign privileges that are based on group membership.

### **Third-Party File Servers**

By using third-party software, you can use an MS-DOS, VAX, Intel, or UNIX computer as a file server on an AppleTalk network. Refer to AppleLink for third-party companies that offer this type of software.

### **Distributed File Serving**

You can run AppleShare and a third-party distributed file server, such as TOPS, on the same network. This arrangement allows you to put files that one user may need to access more often on that user's own computer and files that multiple users need to access on the AppleShare-dedicated file server.

System 7 has a built-in feature that allows users to share files in a distributed file server mode, which eliminates the need for additional software or hardware. Users decide which of the files on their hard drives to share and which not to share. A user can monitor which items on his or her hard drive are marked *shared* and which users are currently connected to that system.

### **Tips for Setting Up and Using the File Server**

When setting up your AppleShare File Server, keep the following tips in mind:

- Keep a copy of the Users and Groups data file on a backup floppy disk. Should you need to rebuild the server, you can restore the Users and Groups data file from the floppy disk copy.
- Do not share applications over the network. Everyone needs a personal copy of the application (and the same version). Users should share only documents.
- Establish network rules governing how to open and close files, where in the topology the master file should reside, etc.

---

## AppleTalk Internet Router 2.0

The AppleTalk Internet Router increases the potential size of a network system by connecting multiple networks (LocalTalk, EtherTalk, and/or TokenTalk) to form an Internet. You can also use the router to define logical zones and isolate high-traffic areas from low-traffic areas.

AppleTalk Internet Router 2.0 software runs on a dedicated or nondedicated Macintosh computer. Depending on the Macintosh computer, you can connect from two to eight networks to the router. A combination of Macintosh serial ports and interface cards (see table) provide the connections.

<b>AppleTalk Internet Routers</b>				
	<b>LocalTalk</b>	<b>EtherTalk</b>	<b>TokenTalk</b>	<b>Maximum Connections</b>
<b>Macintosh Plus</b>	2	0*	0	2*
<b>Macintosh SE, SE/30</b>	2	0*	0	2*
<b>Macintosh IIcx</b>	2	3	3	5
<b>Macintosh II, IIx</b>	2	6	6	8

\* Third-party EtherTalk interface hardware may make an additional network connection possible.

### Note

If you are using an Apple EtherTalk card that you purchased prior to July 1988, check that the revision number on the bottom edge of the connector end of the card is REV K or a later revision. If you have an earlier revision, upgrade to a REV K or later card.

Each AppleTalk router creates a table that lists all networks and routers in the Internet. The router uses this table to determine the most efficient route for each data packet it sends. AppleTalk protocols allow a maximum of 15 hops (a hop is the distance between two routers) in a single transmission path.

---

During router setup, you assign a single number or number range to all networks (except LocalTalk networks). The network number or range must be unique in the Internet.

Each number in a network range represents up to 253 nodes. Each node in that range automatically acquires its own unique node address when you switch it on.

**Note** If EtherTalk software is installed, you must upgrade all routers and workstations to EtherTalk version 2.0 (or later) to support network ranges.

The following table lists the specifications for the AppleTalk Internet Router 2.0.

<b>AppleTalk Internet Router Specifications</b>	
Max. ports per router	8
Max. networks per Internet	1,024
Max. nodes per network (Phase 2)	16,000,000
Max. zones per Internet	256
Hardware required <sup>1</sup>	Macintosh Plus computer or later
Software required <sup>2</sup>	System software version 6.0.3 or later; TokenTalk 2.0 or later for a TokenTalk network; EtherTalk 2.0 or later for an EtherTalk network. AppleShare File Server software 2.0.1 or later if running concurrently on the router.

1 A hard disk is not required for a dedicated router. A nondedicated router running one additional service, such as file sharing, requires a hard disk and 1 MB of RAM; to run two or more additional services requires at least 2 MB of RAM.

2 Always use the latest version of the *Network Software Installer* disk, which is on AppleLink.

---

You can assign an entire network or individual nodes within the network to different zones via the Network control panel. (LocalTalk networks are limited to one zone.) You can assign EtherTalk and TokenTalk networks to zone lists, which you can access from the Chooser. If an Internet has only one zone, all network services appear together in each Macintosh user's Chooser, and no zone name appears.

---

### **Seed Routers**

Each network in the Internet must have at least one seed router, which contains the identifying information for that network (e.g., the network range and zone list). The seed router transmits this information to all other routers directly connected to that network, which eliminates the need for you to re-enter this information in multiple routers. Any router can be a seed router for one network and a nonseed router for another network.

**Note** Phase 1 AppleTalk Internet Routers cannot communicate with Phase 2 AppleTalk Internet Routers without the Phase 2 Upgrade Utility.

---

### **Starting the Internet Router**

**Note** This section assumes that the AppleTalk Internet Router software is already installed and configured; if not, or if you need to make changes to the router's setup, refer to the *AppleTalk Internet Router Administrator's Guide*.

To start up the router, choose **Router** from the Apple menu. The system adds the Router desk accessory to the menu bar, and the Router Setup window (shown in Figure 1) appears.

**Note** If the Restart Status button is On, you can still start up the Macintosh without loading the router software. Hold down the Command key while you switch on the computer until a message indicates that router loading has been canceled.

Router Setup Window	
<b>Current Status</b>	<b>Description</b>
Off	Makes an active router inactive. This setting takes effect immediately and can't be reversed until you restart the router.
On	Confirms the router's status is active. When the router is inactive, this button is dimmed; to turn the router back on, click the Restart Status button and restart the Macintosh computer.
<b>Restart Status</b>	<b>Description</b>
Off	Prevents the router from becoming active at startup. This setting does not affect the router's current operation.
On	Automatically activates the router whenever the Macintosh is started up.

**Figure 1 Router Setup Window**

---

## Internet Router Network Statistics

From the Router menu you can access the Network Information and Port Statistics windows. These windows provide valuable information about the status of the Internet.

### Network Information Window

When you open the Network Information window, you will see statistics pertaining to the following categories:

*Packets Routed*—number of data packets received and forwarded since the last reset of the router.

*Recent Activity Rate*—current level of traffic moving through the router.

*Network Reliability*—percentage of total packets routed without error (an efficient network runs at 98% or above).

*Recent Network Error Rate*—current level (low to high) of errors as a proportion of total router traffic.



---

*Network Range*—network number or range for each connected network.

*Zone Name*—zone name(s) you have defined for the network (which may show only the first listing if you select **summary view**).

*Distance*—distance in hops from this router to the router in the Network Range column.

*Forwarding Port*—port through which the router will transmit a packet in order to reach the network in the Network Range column.

*Next Router*—address of the next router in the path to the network in the Network Range column (the address of the current router appears in parentheses if the network is directly connected to the router).

### **Port Statistics Window**

When you open the Port Statistics window, you will see statistics pertaining to the individual ports on the AppleTalk Internet Router. The categories include:

*Packets In*—number of data packets received for routing.

*Packets Out*—number of data packets routed, which may not equal the Packets In number if transmission errors occur.

*Name Requests In*—number of requests for network device names. If this number is unusually high, there may be a problem on the network connected to that port.

*Name LookUps Out*—number of lookups the router issued in response to name requests.

*Data Link Errors*—number of transmission errors caused by hardware (e.g., a packet corrupted by an improperly terminated network). A router detects only errors in packets that it receives and transmits itself.

*Packet Buffer Overflow*—number of packets the router is discarding because the buffer is full. When the rate of incoming packets is higher than the outgoing rate, the router buffer handles the overflow. Once the buffer is full, the router discards packets until the imbalance is corrected.

---

If this number is consistently high, the distribution of servers or other resources on connected networks may be unbalanced and require correction.

*Unknown Network*—number of times the router has received a request to route a packet to a network not listed in its routing table. Possible causes include a break on the network system (caused by disconnected cables or other hardware malfunctions) or by a problem with one of the other routers on the Internet.

*Hop Count Exceeded*—number of packets the router did not forward because the packets had already traveled 15 hops in a single route—the maximum allowed by AppleTalk protocols. If possible, redesign the network so that no route exceeds 15 hops.

*Routing Table Overflow*—more AppleTalk networks are connected to the Internet than the routing table can store (the maximum is 1024).

*Local Net Setup Conflict*—this router and another router on a connected network have conflicting network numbers or ranges.

*Remote Net Range Conflict*—another router lists a network range that conflicts with the routing table of the current router (ranges may not overlap).

*Router Version Mismatch*—an error that occurs each time the router receives a packet from another router that does not support AppleTalk Phase 2.

---

## Resetting the Statistics

The router calculates totals for each value in the Network Information and Port Statistics windows until you reset the display or shut down the router. To reset the display:

1. Choose **Reset All Statistics** from the Router menu.
2. Click **OK**.

---

## Connecting Networks to the Router Ports

Since you can use the AppleTalk Internet Router with serial peripheral devices, it's possible that a driver for a serial device may be using the printer or modem port. You could

---

experience a networkwide malfunction if you connect a network to a port that one of these serial device drivers is using.

**▲Warning** **Shut down the Macintosh computer that is running the router software before you connect networks to the router.**

---

To connect networks to the router:

**LocalTalk**—plug the LocalTalk connector directly into the printer or modem port on the router. Use both ports if you are connecting two LocalTalk networks.

**EtherTalk**—plug the Ethernet network connector into the Ethernet port on the router. If the router does not have an Ethernet port, or if you plan to connect more than one Ethernet network, you must install an Ethernet interface card.

**TokenTalk**—plug the Token Ring network connector into the Token Ring port on the router. You must install a TokenTalk interface card for each Token Ring network.

---

### **AppleTalk Internet Router Tips**

1. Always start the router before workstations (especially with Phase 2 AppleTalk Internet Routers, which define network numbers and zone name lists).
2. To avoid problems with mismatched network number ranges, use one router as the seed router and enter zero (0) for the start and end ranges on the nonseed router(s). The nonseed router(s) will determine the network number range from the routing table the seed router sends.
3. After correcting a problem that has interrupted router startup (or after you've held down the command key to disable router startup), you must set the router **Restart Status** to On in the Router Setup window. Then start the system.

- 
4. You should not run the AppleTalk Internet Router software on a user's workstation. However, you can run the software on an administrator's workstation.

**Note**

Network performance may decline if you install the router software on a heavily used server.

5. Changing the number or range of a network can cause errors in Internet routing. Nodes in that network become aware of such a change only when you restart them. Until a node restarts, information destined for that node, and information the node sends, will bear an incorrect network address.
6. To avoid conflicts when you change a network's zone name or zone list, you must shut down all routers on the network and make the identical name changes in each seed router for that network. Wait at least 10 minutes before you restart the routers.
7. If you change a zone name to an already existing name (i.e., merge zones), be sure that no network services of the same type in these zones have the same name. For example, two LaserWriter printers named *Alfie* would cause a conflict once they became part of the same zone.

---

### **Troubleshooting Router-Related Problems**

When troubleshooting network problems related to the router, be aware of possible problems caused by:

- Router installation, which may prevent you from locating resource files
- Changes made to the router while it was active, such as locking or filling a system disk
- Constraints of the router, such as insufficient memory available
- Errors in setting up the router
- Corrupted files

If you suspect problems with your router, first make sure all physical connections are intact. Many of the symptoms in the Symptom/Cure Chart section result from a router setup

---

error or a disconnected cable. The presence of an Internet router that does not support AppleTalk Phase 2 could also cause many of these symptoms.

**Note** The AppleTalk Internet Router software detects and reports on most types of router-related problems. (Refer to the *AppleTalk Internet Router Administrator's Guide* for an explanation of the error messages.)

If you can't detect the cause of the problem, as a last resort remove and reinstall the router software. Before doing so, print a record of the current router setup. Duplicate the setup in the new router file.

---

### Symptom/Cure Chart

Refer to the following symptom/cure chart to troubleshoot router-related network problems.

#### Router Communication Problems

Two routers on the same Internet can't communicate with one another

**Cause:** One router is running AppleTalk Phase 1 and the other is running AppleTalk Phase 2.

**Solution:** Replace the AppleTalk Phase 1 router, or use the Phase 2 Upgrade Utility.

#### Router Startup Delays

The router experiences a long delay during startup

**Cause:** An EtherTalk card in the router has an improperly terminated port or cable.

**Solution:** Check the router's EtherTalk card(s). If you are using thin Ethernet cabling and don't have a cable connected to the EtherTalk port, you must plug a T-shaped Ethernet connector into the port and install two Ethernet cable terminators on the connector. If you have a cable that is connected to only one side of the connector, you must have a terminator on the other side. You must also properly terminate both ends of cable(s) that extend from the connector.

If no terminators are missing from an EtherTalk connection, check for a break along the Ethernet cable. A cable that has a break or an improperly terminated cable can produce the same symptoms. After you check all connections, restart the router.

---

## Chooser Problems

Zone name or network device missing from Chooser on one or more workstations

**Cause 1:** Two or more networks have the same number or overlapping network ranges. Only the first of the conflicting networks is recognized.

**Solution 1:** Assign new network numbers or ranges to the conflicting networks.

**Cause 2:** More than 256 zones are defined in the AppleTalk Internet.

**Solution 2:** Eliminate or merge zones.

One or more devices appear in the wrong zone in a workstation Chooser

**Cause 1:** A zone name has changed. Users in the zone whose name changed can't see the same zones as other users on the network.

**Solution 1:** Shut down all routers connected to the network that contains the zone with the changed name. Wait 10 minutes for all routers to update their router tables. Restart the routers.

**Cause 2:** A Phase 2 network user selected the wrong zone name and, therefore, the device doesn't appear in the expected zone.

**Solution 2:** The user should select the correct zone name.

**Cause 3:** You are using one Macintosh computer as a router and a server, and you have selected the wrong port as the user's port or assigned the port to the wrong zone.

**Solution 3:** Shut down the router and change the user's port or select a different zone.

Devices that should appear in the same zone do not

**Cause 1:** Zone names for one or more networks were entered incorrectly in the Router Setup window.

**Solution 1:** Check the seed routers for the affected network(s). Be sure the zone names are identical for each network (the order of the zone names is not important and the names need not match uppercase and lowercase). All characters, including the space character, count as valid characters in the zone name.

**Cause 2:** The wrong zone name is selected in the Network control panel for one or more network nodes.

**Solution 2:** Have users that are experiencing this problem select the correct zone.

## Display Problems

The text in the Router desk accessory windows is illegible or has the wrong font

**Cause:** The router doesn't have the necessary fonts.

**Solution:** The Router desk accessory requires 10-point Geneva, 10-point Courier, and 12-point Chicago. Install any missing fonts.

---

A network port you've installed in the router doesn't appear in the Router Setup window for you to configure

### Missing Network

A network is missing from the listing in the router's Network Information window

**Cause:** The network software for that interface card is not installed.

**Solution:** If a modem or printer port is missing, reinstall the router software. If a network interface card is missing, reinstall the software for that card.

**Cause 1:** You didn't establish a seed router for the missing network. None of the routers has received a number for the missing network.

**Solution 1:** Create a seed router for the missing network. Open the Router Setup window on a router that is connected to the missing network and enter a network number and zone name.

**Cause 2:** A router port to which the missing network is directly connected was switched off. If more than one network is missing from the list, there may be an inactive port on a router somewhere in the path to these networks (on a router that is one or more hops from the missing networks).

**Solution 2:** Check the setup information in routers connected to the missing network(s). Make sure that all ports routing to the network(s) are active.

**Cause 3:** The missing network is more than 15 hops away.

**Solution 3:** Modify the placement of routers in the Internet so that no route exceeds 15 hops.

**Cause 4:** There are more than 1024 networks in the Internet.

**Solution 4:** Combine networks, or use nonrouting bridge devices to combine groups of separate networks into larger networks.

### Misc. Problems

Device doesn't work, or device that responds is not the one you thought you selected

**Cause:** There may be more than one device with the same name.

**Solution:** In the zone where the problem occurred, check the names of all devices of the type that is experiencing the problem. Rename duplicates or restart all devices of the type experiencing the problem. The AppleTalk software will automatically correct the problem at startup by appending numbers to the ends of duplicate names.\*

---

\* When the router automatically assigns node names, these names can change once you switch equipment off. For example, the router may assign printer A the name LaserWriter 1, and printer B the name LaserWriter 2. If you switch off these printers and then switch on printer B before printer A, the names will be reversed. Therefore, it is best to manually assign node names whenever possible.

---

## System 7

System 7.0 (and later) system software provides several networking features, such as the ability to:

- Access information on other computers—you can connect to another computer and access files.
- Share files from your own computer—you can make folders and disks on your computer available to others on the network and specify what access privileges they have.
- Update files automatically—when you update a file on a shared computer you update all shared copies of the file as well.
- Print documents on network printers—by selecting a network printer through the Chooser, you can print as soon as you connect to the network.
- Link programs to programs on other computers—by linking programs you can share features, such as sharing a dictionary between word processing programs.

**Note** System 7.0 supports AppleShare 3.0; System 7.1 supports AppleShare 3.0.1.

---

### Installing Networking Software

The Macintosh Communications Toolbox, Apple Data Stream Protocol (ADSP), and Data Access Language (DAL) are built into System 7, so you need not install them.

### Software Drivers

The System 7 installation disks contain EtherTalk and TokenTalk software drivers. These drivers are automatically installed with System 7 if the Apple equipment has the appropriate hardware support (expansion card or built-in support) prior to software installation.

**Note** Although the EtherTalk and TokenTalk drivers are automatically installed with System 7, it is best to upgrade to the latest version of the software, which you can find on the *Network Software Installer* disk on AppleLink.





If you want to install additional networking software (or the latest versions of EtherTalk and TokenTalk software), use the



---

Installer program on one of the System 7 installation disks and use the Customize option. This process allows you to install additional software without disturbing the rest of the system software. Refer to the *Macintosh Networking Reference* manual for more information.

Use the following table to determine what networking software is installed.

Feature	Where to look	What you'll see when installed
File Access	Chooser	 AppleShare
File Sharing	Sharing Setup Control Panel	 <b>File Sharing</b>
TokenTalk Connection	Network Control Panel	 TokenTalk
EtherTalk Connection	Network Control Panel	 EtherTalk
Program Linking	(always installed)	

---

## Preparing for Network Use

The following sections explain how to set up an individual computer workstation for network use.

### Selecting AppleTalk

To select or deselect AppleTalk, open the Chooser and click the Active or Inactive button.

### Selecting a Network Connection and Zone

Use the Network control panel, which is in Control Panels under the Apple menu, to select a network connection by clicking on the associated icon. After you connect to an EtherTalk or TokenTalk network, you can also click a zone name to assign the Macintosh computer to that zone.

---

## Naming the Macintosh Computer and Its Owner

Once you assign a name to a Macintosh computer, the name appears in the Chooser of other computers on the network. If you are going to use file sharing to share folders, you need to name yourself as the owner of the computer. You have to enter this information only once.

To name the Macintosh computer:

1. Choose **Control Panels** from the Apple menu and open the Sharing Setup control panel.
2. Enter the owner's name and password and a name for the Macintosh computer in the appropriate fields.

## Connecting to Shared Disks or File Servers

To connect to a shared disk or file server on the network:

1. Open the Chooser and make sure AppleTalk is active.
2. Click the AppleShare icon to display available file servers. If more than one zone appears, click the zone of your choice. The computers and file servers in that zone will appear.
3. Click the file server or computer that has the shared disk you want to use.
4. Click **OK**. A dialog box will appear.
5. Click **Guest** or **Registered User**.
  - a. If the Guest option is dimmed, it means that only registered users have access to that computer.
  - b. If you are connecting as a registered user, make sure to enter your name exactly as registered, type in your password (case sensitive), and click **OK**.
6. Select the name of the shared disk(s) you want to share. A dimmed name indicates that you are already connected to that shared disk or that you don't have access privileges.
7. Click **OK** and close the Chooser.

---

## File Sharing in System 7

To utilize the file-sharing capabilities of System 7, the user must first activate the file sharing option at his or her own computer as follows:

1. Name the Macintosh. (See Naming the Macintosh Computer and Its Owner.)
2. Choose **Control Panels** from the Apple menu. Open the Sharing Setup control panel.
3. Click the file-sharing Start button to allow file sharing, or the Stop button to discontinue file sharing.
4. Close the Sharing Setup control panel and the Control Panels folder.

### Note

Once file sharing is on, it stays on until the user inactivates it in the Sharing Setup control panel.

Refer to the *Macintosh Networking Reference System 7* manual for information about how to mark specific folders or disks as shared and how to specify access privileges.

---

## Troubleshooting System 7 Networking Problems

Before you begin troubleshooting System 7 networking problems:

- Make sure the network software was installed using the Installer program on one of the Apple system disks.
- Do not move extension files and preferences files from the Extensions folder or Preferences folder in which they are installed.
- Make sure your Macintosh is properly connected to the network. Secure all cables and expansion cards.
- Switch on and use Balloon Help™ to determine why menu items or commands are dimmed or inactive.
- If you are having problems finding, opening, or saving changes to files and folders on shared disks, check your access privileges. (Refer to the *Macintosh Networking Reference* manual for more information.)

---

## Symptom/Cure Chart

The following symptom/cure chart will help you troubleshoot System 7 problems.

### Problems Using the Chooser

Nothing appears in the upper-left section of the Chooser

### Solutions

- Make sure the files for the network services you want are in the Extensions folder.

A computer, printer, or other device is not listed on the right side of the Chooser

1. Make sure you have selected the type of device you want in the upper-left section of the Chooser.
2. If your network has zones, make sure you open the Chooser and select the zone containing the device you want from the AppleTalk zones list.
3. If you are trying to connect to a file-sharing computer, that computer may be switched off, or file sharing may be disabled. Check with the owner of the computer.

You don't know where to enter your user name

- System software versions prior to version 7.0 allowed you to enter your user name in the Chooser. However, in versions 7.0 and later, you must enter your user name in the Sharing Setup control panel.

You can't connect as a guest

- If the Guest selection is dimmed when you try to connect to another computer, it means that guests are not allowed to connect to that computer.

Your user name or password is not accepted

1. Check with the Macintosh owner or network administrator to make sure that you are registered and that you have the right name and password.
2. Check the spelling of your password to make sure it matches the way it was registered on the computer you're connecting to, including uppercase and lowercase. Check that the Caps Lock key is not depressed.

You can't find a file or folder on a shared disk

- You may not have sufficient access privileges to see the file or folder. Check the small icons in the upper-left corner of the open window on the shared disk.

### Problems Using the Control Panels

Problems with the Users & Groups control panel

### Solutions

- If no owner icon appears in this control panel, you have not entered a user name in the Sharing Setup control panel.

You can't find the Network control panel

- The Network control panel is installed on your system only if you have an EtherTalk or TokenTalk expansion card and its associated software installed in your computer.

- 
- |   |  |
|---|--|
| <p>EtherTalk or TokenTalk icons do not appear when you open the Network control panel</p> | <ol style="list-style-type: none"> <li>1. These icons are installed on your system only if you install an EtherTalk or TokenTalk expansion card and its associated software in your computer <i>prior to installing the system software</i>.</li> <li>2. The EtherTalk or TokenTalk card could be malfunctioning. Replace the card.</li> </ol> |
| <p>You can't find the Sharing Setup control panel</p>                                     | <ul style="list-style-type: none"> <li>– Make sure the File Sharing Extension file and the Network Extension file are in the Extensions folder and that the Sharing Setup control panel is in the Control Panels folder of your System folder. Restart your computer.</li> </ul>   |
| <p>Sharing Setup icon won't open</p>  | <ul style="list-style-type: none"> <li>– Make sure the File Sharing Extension file and the Network Extension file are in the Extensions folder and that the Sharing Setup control panel is in the Control Panels folder of your System folder. Restart your computer.</li> </ul>   |
| <p>File sharing section of the control panel doesn't appear</p>                           | <ul style="list-style-type: none"> <li>– Make sure the File Sharing Extension file and the Network Extension file are in the Extensions folder and that the Sharing Setup control panel is in the Control Panels folder of your System folder. Restart your computer.</li> </ul>   |

**Problems Using the Sharing Command      Solutions**

- |  |  |
|--|--|
| <p>The Sharing command is dimmed</p>   | <ul style="list-style-type: none"> <li>– The Sharing command is dimmed when you have not selected a folder, disk, or program to share.</li> </ul>  |
| <p>Checkbox labeled <i>Share this item and its contents</i> doesn't appear in the Sharing window</p> | <ul style="list-style-type: none"> <li>– This checkbox will not appear for folders that are within a folder or disk that you have already shared. Folders within a shared folder or disk are considered shared too.</li> </ul> |
| <p>Checkbox labeled <i>Allow remote program linking</i> is dimmed</p>                                | <ul style="list-style-type: none"> <li>– This checkbox appears in the Sharing dialog window when you have selected a program. The checkbox is dimmed if the program you selected doesn't support program linking.</li> </ul>   |

**Access Problems      Solutions**

- |   |   |
|---|---|
| <p>A shared volume doesn't appear in the shared items list or is dimmed</p> | <ul style="list-style-type: none"> <li>– The volume is not shared or you don't have access privileges.</li> </ul> |
|---|---|

---

## AppleTalk Remote Access 1.0

AppleTalk Remote Access is software that lets one Macintosh computer communicate with another over standard telephone lines. With this software, you can take advantage of all the AppleTalk services on a remote network, and you can access host services via gateways on the remote network. It doesn't matter what type of AppleTalk network (LocalTalk, EtherTalk, or TokenTalk) you call into—the program adjusts automatically to the network you're calling.

Once you've installed the AppleTalk Remote Access software, you can allow other users to call your computer and, through Macintosh file sharing, share and exchange files. The Remote Access program does not need to be open in order to answer calls—it automatically answers in the background.

---

### Operating Requirements

To utilize the AppleTalk Remote Access software, you need:

- System software version 7.0 or later
- Macintosh Plus or later computer (including PowerBook computers) with at least 2 MB of RAM (4 MB of RAM recommended)
- AppleTalk Remote Access installed on the calling and answering sides
- Apple or Hayes-compatible modem (2400 bps minimum; 9600 bps recommended) on the calling and answering sides
- Appropriate modem cable

#### Note

Refer to the *AppleTalk Remote Access User's Guide* for installation instructions.

---

### Modem Support and Scripts

AppleTalk Remote Access 1.0 works with any Apple 2400 bps or Hayes-compatible 2400 bps or higher-speed modem that has the appropriate script. AppleTalk Remote Access includes the modem scripts in the following table.

#### Note

Other modem scripts may be available on AppleLink.

---

<b>AppleTalk Remote Access Modem Scripts</b>	
<b>2400 bps Modems</b>	<b>9600 bps Modems</b>
Apple Data Modems	DSI 9624LE/LE Plus
Abaton InterFax 24/96	Hayes Ultra 96
Global Village TelePort	Farallon Remote V.32
Hayes SmartModem 2400	Microcom MacModem V.32
Microcom Microport 1024	MultiTech MultiModem V32
Practical Peripherals 2400SA	Practical Peripherals 9600SA
Prometheus 2400M	Prometheus ProModem Ultima
Supra SupraModem 2400	Telebit T1600
US Robotics Courier 2400c	US Robotics Courier V.32bis

---

### **Specifications**

The following specifications apply to the AppleTalk Remote Access program:

- User name maximum length = 31 characters
- Password maximum length = 8 characters
- Maximum connect time = selectable
- Maximum Activity Log entries = 1000
- Password attempt retry limit = 7 attempts
- Error detection = MNP
- Data compression = V.42bis

---

### **Symptom/Cure Chart**

The following symptom/cure chart will help you troubleshoot the AppleTalk Remote Access product. (Refer to the *AppleTalk Remote Access User's Guide* for more information.)

---

<b>Problem</b>	<b>Solutions</b>
<p>You can't connect to the remote network</p>	<ol style="list-style-type: none"> <li>1. Make sure the modem is connected properly and switched on.</li> <li>2. Make sure the modem type and port are selected in the Remote Access Setup control panel.</li> </ol>
<p>The modem works, but you can't connect to another Macintosh computer</p>	<ol style="list-style-type: none"> <li>1. Make sure you're a registered user on the other Macintosh computer. Check that you've entered your user name, password, and remote server phone number correctly in your connection document.</li> <li>2. Find out if the other Macintosh computer is set up to call you back, and verify that your telephone number is correct.</li> <li>3. Make sure the other Macintosh computer and its modem are switched on, and the Macintosh is set up to answer calls.</li> </ol>
<p>You are losing the connection</p>	<ol style="list-style-type: none"> <li>1. Make sure you've selected the correct modem type in the Remote Access Setup control panel.</li> <li>2. Make sure no one is picking up a phone on the same line while you're connected.</li> <li>3. The call-waiting feature can disrupt the connection. Contact your phone company for information on how to switch off call waiting.</li> <li>4. You may have noisy phone lines. Contact your phone company.</li> <li>5. To verify that the modem is functioning properly, refer to the user's manual for the modem.</li> </ol>
<p>The response time from the remote network is slow</p>	<ul style="list-style-type: none"> <li>– Check the modem settings to make sure the modems are connecting at the highest speed that they support.</li> </ul>
<p>After you connect to a remote network, you have problems with your ImageWriter or another device that is connected to the printer port</p>	<ol style="list-style-type: none"> <li>1. Select <b>Remote Only</b> in the Network control panel to redirect AppleTalk and to allow you to print to your serial printer.</li> <li>2. Check the Chooser to be sure you selected the serial printer to which you are trying to print.</li> </ol>
<p>After you connect to a remote network, you can't access your local network</p>	<ul style="list-style-type: none"> <li>– Select <b>LocalTalk</b>, <b>EtherTalk</b>, or <b>TokenTalk</b> in the Network control panel.</li> </ul>
<p><i>Remote access software not properly installed</i> message appears at startup</p>	<ol style="list-style-type: none"> <li>1. If you are using System 7 Tuneup, activate AppleTalk via the Chooser and restart the computer.</li> <li>2. Reinstall the AppleTalk Remote Access software.</li> </ol>



- 
- |   |  |
|---|--|
| Certain network applications are slow or timeout  | – Install the latest version of the network software that is compatible with AppleTalk Remote Access.  |
| Other programs that use the serial port don't function properly                             | – When you select the option <b>Answer calls</b> in the Remote Access Setup control panel, AppleTalk Remote Access is using the serial port. To use other programs that need the serial port, switch off the <b>Answer calls</b> option. |
| You see a dialog box that says the serial port is in use                                    | – When you select the option <b>Answer calls</b> in the Remote Access Setup control panel, AppleTalk Remote Access is using the serial port. To use other programs that need the serial port, switch off the <b>Answer calls</b> option. |
| Your computer freezes during shutdown   | – When you select the option <b>Answer calls</b> in the Remote Access Setup control panel, AppleTalk Remote Access is using the serial port. To use other programs that need the serial port, switch off the <b>Answer calls</b> option. |
| After you connect to a remote network, you can't see certain services on the remote network | – Select <b>Remote Only</b> in the Network control panel. While <b>Remote Only</b> is selected, you will not have access to your local network.  |

To attach an Apple computer to an EtherTalk or TokenTalk network, you must have the proper network interface software installed on the computer.

---

### **EtherTalk 2.0**

EtherTalk 2.0 (and later) software supports AppleTalk Phase 2 protocols that run on a Macintosh computer connected to an Ethernet network. The software includes support for extended addressing.

A Macintosh computer that runs EtherTalk 2.0 (or later) software can access services on other EtherTalk 2.0 nodes, such as an AppleShare File Server, or can use the AppleTalk Internet Router to reach services on other AppleTalk networks, such as a LaserWriter on a LocalTalk network.

Although EtherTalk software is part of System 7, always install the most recent version, which is on the *Network Software Installer* disk on AppleLink.

---

### **TokenTalk 2.0**

TokenTalk 2.0 (and later) software supports AppleTalk Phase 2 protocols that run on a Macintosh computer connected to a Token Ring network. The software includes support for extended addressing.

A Macintosh computer that runs TokenTalk 2.0 (or later) software can access services on other TokenTalk 2.0 nodes, such as an AppleShare File Server, or can use the AppleTalk Internet Router to reach services on other AppleTalk networks, such as a LaserWriter on a LocalTalk network. In addition, TokenTalk 2.0 nodes can communicate with other TokenTalk nodes that are on the other side of one or more IBM source routing bridges.

Although TokenTalk software is part of System 7, always install the most recent version, which is on the *Network Software Installer* disk on AppleLink.

### **MacX25**

MacX25™ software links Macintosh computers to packet-switched data networks (PSDNs) that support CCITT Recommendation X.25. MacX25 Server allows you to set up a Macintosh as a single entry point to the PSDN. The server distributes access to host computers and end-user services on the PSDN to other Macintosh computers over the AppleTalk network.

MacPAD® software, included with the MacX25 server, provides Packet Assembler Disassemblers (PADs) connectivity to the PSDN. MacPAD is a connection tool for the Macintosh Communications Toolbox, which allows terminal applications that use the toolbox to connect to host systems on the PSDN.

For more information about MacX25, refer to *MacX25 Administrator's Guide* or *MacX25 User's Guide*.

---

### **MacTCP**

Software developers can use MacTCP® to create Macintosh applications and solutions for TCP/IP network environments. MacTCP is co-resident with the AppleTalk protocols and runs over LocalTalk, Ethernet, and Token Ring cable systems.

Macintosh applications that interface to TCP/IP networks require MacTCP software. For more information about MacTCP, refer to the user's guide for the third-party software application.

---

### **SNA•ps 3270**

SNA•ps 3270 (Systems Network Architecture protocols and services) is a 3270 display terminal emulation program that enables Macintosh computers to communicate with IBM mainframes. It provides Control Unit Terminal (CUT) and Distributed Function Terminal (DFT) emulation of IBM 3270 Information Display Systems.

The SNA•ps 3270 application software works with the Apple Coax/Twinax Card, Apple TokenTalk NB Card, or Apple Serial NB Card in any Macintosh II system and supports up to

---

five direct or AppleTalk-distributed 3270 sessions. In an AppleTalk network with an SNA•ps Gateway installed, SNA•ps 3270 users can access host services from any Macintosh computer. In addition, users can access multiple gateways for concurrent access to multiple hosts.

For more information about SNA•ps, refer to *SNA•ps 3270 User's Guide*.

---

### **SNA•ps Gateway**

The SNA•ps Gateway is an integrated 3270, Advanced Program-to-Program Communications (APPC), and Advanced Peer-to-Peer Networking (APPN) gateway. You can configure the SNA•ps Gateway as a personal gateway for direct SNA connectivity or as an AppleTalk network gateway to enable any Macintosh computer to communicate with IBM systems running the VM, MVS, OS/400, and OS/2 operating systems.

For more information about SNA•ps Gateway, refer to *SNA•ps 3270 User's Guide*.

---

### **Macintosh Communications Toolbox**

The Macintosh Communications Toolbox is system software that provides applications with standard access to communications services. There are three types of communications tools, and each provides the application with a specific communications function:

- Connection tools—define the type of connection that is established between a Macintosh and another computer.
- Terminal emulation tools—determine the type of terminal that a Macintosh computer emulates during the communications session.
- File transfer tools—implement the protocol that ensures that files transfer intact.

The Macintosh Communications Toolbox is included with System 7. With System 6, you must install the Communications Toolbox via the *Communications 1* disk; the *Communications 1* disk ships with third-party software packages that use the Communications Toolbox.

---

### **MacTerminal 3.0**

MacTerminal 3.0 is a terminal emulation and communications application that enables Apple Macintosh personal computers to communicate with many host computers, such as VAX and UNIX systems. This application allows users to access electronic bulletin boards and on-line databases, such as CompuServe. With MacTerminal 3.0, Macintosh computers appear as RS-232 terminals and can be directly connected to the host system via RS-232 cable, remotely via a modem, or through a LAT terminal server connected to the VAX via Ethernet.

The most common way for Macintosh computers to communicate with IBM host processors is by emulating IBM 3278 terminals. Macintosh computers connect to the same coaxial cable as the 3278 terminals. You can connect Macintosh computers to an IBM mainframe (3270 environment) in one of three ways:

- Coaxial connection—directly replacing a 3270-type terminal
- Network connection
- Asynchronous connection—via RS-232 cable

For more information about MacTerminal 3.0, refer to *MacTerminal User's Guide*.

---

### **Data Access Language Server for VAX and VMS**

This networking software provides Data Access Language access to files and databases on VAX and VMS host systems. When the server receives a request from a Macintosh application that supports Data Access Language, the server carries out the request on the VAX and sends the desired data back to the Macintosh application.

---

## Inter•Poll Network Administrator's Utility

The Inter•Poll Network Administrator's Utility contains tools that an AppleTalk network administrator can use to implement a network support program. These tools cover network mapping, troubleshooting methods, selective searches for active devices, network-link integrity tests, and version reporting for workstation system software. Together, these tools help the AppleTalk network administrator eliminate many network problems before the problems adversely affect users.

Refer to the General Network Troubleshooting chapter for information about how you can use Apple Inter•Poll software to troubleshoot an AppleTalk network.

# General Network Troubleshooting

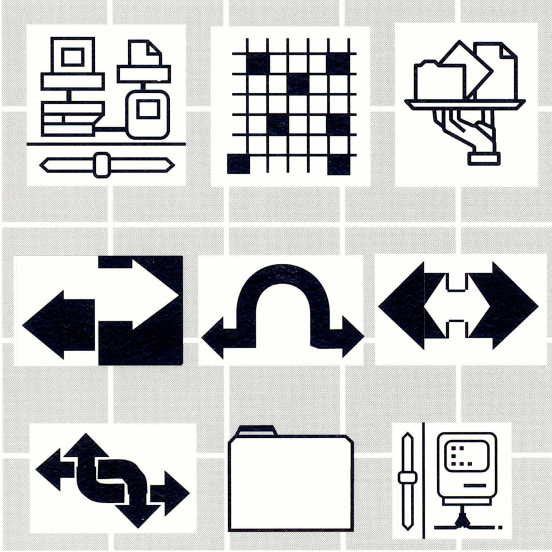

---

General Troubleshooting	
Approaches	136
Diagnostic Tools	139
Inter•Poll Software	141
Symptom/Cure Chart for General Troubleshooting	147

## General Troubleshooting Approaches

Diagnosing and troubleshooting network problems requires a certain level of creativity. Although guides like this one can give you tips and recommendations, each network configuration is unique.

The following table indicates the order in which you should troubleshoot network equipment.

<b>General Troubleshooting Approach</b>	
<b>Devices Displaying Symptoms</b>	<b>Troubleshooting Order</b>
One workstation and one shared device	1) Workstation 2) Cable <sup>1</sup> 3) Shared device
One workstation and multiple shared devices	1) Workstation 2) Cable <sup>2</sup> 3) Shared devices
Multiple workstations and one shared device	1) Shared device 2) Cable <sup>2</sup> 3) Workstation
Multiple workstations and multiple shared devices	1) Cable 2) Shared devices 3) Workstation

1 If problem is intermittent, check cabling first.  
2 If problem is intermittent or in one physical area, check cabling first.

When troubleshooting any network, be sure to:

- Gather detailed information on the symptoms and make sure the problem is network related. If possible, re-create the problem.
- Isolate the problem using a top-down approach. Identify the symptoms, make a list of possible causes, and then gather more information to narrow the list of possible causes. If possible, try to isolate the problem to a component level.



- 
- Check and correct hardware or software problems at the workstation level first; then work your way out to the network at large.

---

## **Most Common Network Problems**

Network problems fall into the following categories:

- Cables
- Cards
- Individual nodes
- Power sources
- Software
- User errors

### **Cables**

Intermittent problems are most likely due to cable problems. These problems include broken, damaged, or incompatible cables; networks that extend beyond the recommended cable length; external factors such as EMI; and incorrectly connected cables.

Perform a visual inspection of the cabling to be sure no cables are broken or pinched. Check that the cable connections are secure and that there are no broken or bent pins on the cable connectors. Be aware of where the cable runs and check for possible EMI problems that can be caused by static electricity, fluorescent lighting, or heavy machinery operating nearby.

**Note** Cables that appear to be connected may be loose. Check cable connections by hand to be sure they are secure.

### **Cards**

When troubleshooting card problems, look for missing cards, incompatible card versions, damaged cards, cards that are not properly seated, and cards that are not configured properly. Refer to the Apple Networking Hardware chapter for proper card versions for all Apple equipment. Make sure nodes on the network are operating at the same speed.

---

## Individual Nodes

You can have problems with an individual printer, computer, or peripheral device, such as a modem or hard drive. Look for problems with incompatible equipment, defective hardware, insufficient memory, hardware that is not configured properly, or two or more nodes that have the same node address. To verify compatibility and configuration information, refer to the user manual for the specific device.

## Power Source

Power problems can be hard to diagnose because they are often intermittent. When troubleshooting a power source, look for problems with erratic power, low power, or power spikes and surges. Use a volt/ohmmeter to diagnose power problems.

## Software

Corrupted software, incompatible versions of software, or software that has been incorrectly configured can cause network problems. For example, if you are experiencing printer problems, make sure that all workstations sharing the printer are using the same printer driver.

The best way to determine a software failure is to install a known-good copy of the software and test the network. If the known-good copy works, check for differences between the two copies. If the setup is identical and you cannot locate any user errors, the software is probably damaged. Refer to the *Service Programs* manual on *Service Source* for media exchange information.

## User Errors

User errors may result when users:

- Install nodes incorrectly
- Install applications incorrectly
- Forget to turn on a node
- Operate an AppleTalk application incorrectly
- Forget to check for application compatibility

---

## Diagnostic Tools

There are a number of tools that will help you troubleshoot a network. These tools are described in the following sections and in the Inter•Poll Software section later in this chapter.

---

### Network Log

When troubleshooting a network, it helps to have a network log. The log should include a list of the equipment on the network, the software on the network, the versions of all network products, and the dates and nature of all network changes. You can use Apple's Inter•Poll software to find out what versions of system software, Finder, and LaserWriter drivers are being used on each computer on the network.

If you experience problems with equipment that was previously operational, the problem is often related to recent network changes. The log will help you pinpoint such changes.

---

### Network Map

A network map identifies all nodes on the network. Start your network map with a copy of the building floor plan. Use the network map to:

- Determine when routers are needed
- Determine the optimum placement of routers for the least number of hops between all connected networks
- Help troubleshoot network problems, especially cable problems

#### Note

On a serial bus network, the most important information on the network map is the order of nodes and the length of the cables.

---

### Traffic Monitoring Software

Third-party traffic-monitoring software packages allow you to identify:

- Which devices are generating traffic
- How much traffic is generated
- When traffic occurs

---

It's a good idea to gather representative traffic data on a routine basis to help optimize network performance over time. Run traffic reports after you make changes to the network and compare the data to your daily reports. Check for differences in the reports that may alert you to potential problems. If you see excessive traffic on an Internet, try relocating or adding servers, printers, or computers—or try to restructure the affected networks to balance traffic.

---

## Hardware Tools

There are a number of hardware tools you can use to diagnose problems on AppleTalk networks.

### Small-to-Medium Networks

You will find it helpful to have the following tools when troubleshooting small-to-medium sized networks.

- **Voltmeter and Continuity Checker**—identify network cable problems such as breaks, shorts, improper voltage, and open circuits.
- **Cable Tester**—determines the length of a network cable
- **Electrical Ground Tester**—checks three-pronged electrical outlets and modular phone jacks for proper installation, and detects the loss of a ground wire

### Large Networks

You will find it helpful to have the following tools when troubleshooting large networks.

- **Protocol Analyzer**—analyzes individual packets destined for a particular type of network (Ethernet, Token Ring, etc.)
- **Time-Domain Reflectometers**—checks for breaks or shorts in the cable, locates cables in walls, indicates if a cable has been crimped, and measures cable segments

Inter•Poll is a software tool that helps network administrators monitor activity and analyze problems on an AppleTalk network. With Inter•Poll, you can:

- Display listings of zones, connected networks, and active network devices
- Verify the connection status of any part of a network or Internet
- Test the integrity and response of the network path to a specific device
- Query active workstations in an AppleTalk Internet for a report of current system software versions

Inter•Poll helps you isolate network problems by searching for and reporting on the active devices in a network. By comparing the active device list with a network map, you can determine which devices are missing from the network. Inter•Poll can also test the integrity and response time of network connections by sending loopback tests to other devices on the network. The information returned helps you identify the origin of a transmission problem.

---

### Using Inter•Poll

To start Inter•Poll, double-click the application icon. Upon startup, Inter•Poll displays the Network Search window in Figure 1.

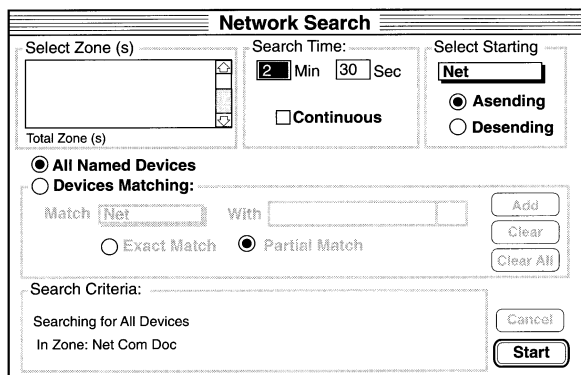

**Figure 1 Network Search Window**

---

Use this window to specify which zone(s) to search, the search time, and the sorting order (by network number, device name, node number, socket number, device type, or zone). You can search for all named devices or for devices that match a given network number, device type, or device name.

**Note**

Inter•Poll can perform searches over networks and Internets that use the AppleTalk Protocol Architecture but cannot extend across gateways into foreign protocol networks.

**Device List Window**

Once the network search begins, the Device List window in Figure 2 appears. This window shows the results of the search.

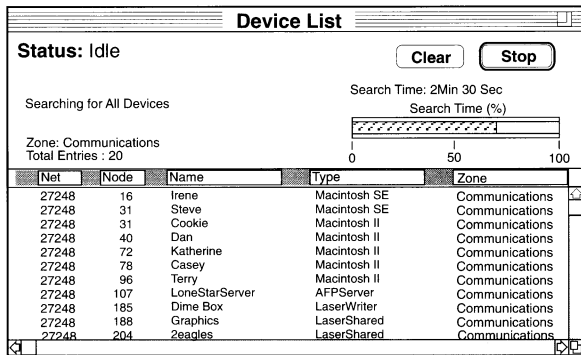

**Figure 2 Device List Window**

Use the Stop button to terminate the search at any time. You can resize, print, or save the device list as a text-delimited text file. Compare the active device list with your network map to determine which devices are missing from the network.

---

## Test Device Window

Use the Test Device window in Figure 3 to send echo, printer, or system information packets to other devices on the network.

The screenshot shows a window titled "Test Device" with the following content:

Device: Net: 27248 Node: 16  
Steve - Macintosh II - Communications

Packets:  Using:  Echo Pkts  Printer Status Packets  System Info Packets

Interval:

Timeout:

---

Packets Sent : Rcvd: 4 Lost: 0  
Left: 16 Total: 4

	Current	Average	Minimum	Maximum
Hops Away	0	0.00	0	0
Delay (secs)	0.00	0.00	0.00	0.00

Status  
Macintosh System File version 6.08 Copyright Apple Computer, Inc. 19  
Macintosh Finder version 6.1  
LaserWriter: version 6.0 April 1990  
Responder INIT version 12  
AppleTalk Driver Version: 50 AppleShare Version 1.1

**Figure 3 Test Device Window**

- Echo packets test other workstations and servers. The information returned includes the number of hops the packets traveled (that is, the number of Internet routers crossed); time delay (in seconds); and the number of packets sent, received, and lost.
- Printer packets test LaserWriters, ImageWriter II printers with the AppleTalk Option, and other devices that use the Printer Access Protocol (PAP). In addition to distance, time, and number of packets, printer status packets also return printer status messages.
- System information packets query Macintosh nodes for current system software versions. The information returned includes the versions of system software, Finder, LaserWriter driver, Responder, AppleTalk, and AppleShare software.

---

## Troubleshooting with Inter•Poll

Troubleshooting with Inter•Poll is a sequential process that isolates network problems. Begin troubleshooting by performing a network search of All Named Devices. Compare the active device list with your network map to determine which zone, network, or device is missing from the network. Go to the last responding node on the path to the missing device and check connectors, cables, and cable termination.

If checks of hardware and cabling fail to isolate the problem, perform additional network searches or loopback tests at the network or device level.

### Missing Zone

To locate a missing zone with Inter•Poll:

1. Using your network map, determine the location of the missing zone(s) relative to the Inter•Poll workstation.
2. Select the zone adjacent to the missing zone and nearest the Inter•Poll workstation, and perform an All Named Devices listing to reveal the possible break point.
3. Determine from your network map which device is the last responding node on the path to the missing zone.
4. Go to the location of this last device and check:
  - a. Connectors and cable termination
  - b. The bridge connecting the missing zone to the "visible" part of the Internet
5. Repair or replace malfunctioning devices or cables. Try displaying the missing zone again.
6. If you find no visible breaks and if local checks of hardware and cabling fail to solve the problem, install Inter•Poll on a Macintosh computer in the nonresponding zone and:
  - a. Perform an All Named Devices listing.
  - b. Compare the device list with the network map.
  - c. If any device within the zone is missing from the list, check hardware and cables at that location.
7. If the process in step 6 does not locate the trouble source, perform loopback tests from the Inter•Poll workstation inside the zone.



- 
- a. Check the router that connects the zone to the Internet.
  - b. If you receive no response, test each device (starting with the bridge) until you isolate the break.

### **Missing Network**

To locate a missing network with Inter•Poll:

1. Using your network map, determine the location of the missing network relative to the Inter•Poll workstation.
2. Perform an All Named Devices listing of the zone that contains the missing network. Using your network map, identify the last responding node on the path to the missing network.
3. Go to the location of this last device and check:
  - a. Connectors and cable termination
  - b. The router connecting the missing network to the "visible" part of the Internet
4. Repair or replace malfunctioning devices or cables. Try displaying the missing network again.
5. If you find no visible break and if checks of hardware and cabling fail to solve the problem, install Inter•Poll on a Macintosh computer on the nonresponding network. Then:
  - a. Perform an All Named Devices listing of the local zone.
  - b. Compare the device list with the network map.
  - c. If any device within the network is missing from the list, check cables and hardware at that location.
6. If the process in step 5 does not locate the trouble source, perform loopback tests from the Inter•Poll workstation inside the network.
  - a. Check the bridge that connects the network to the Internet.
  - b. If you receive no response, test each contiguous device (starting with the bridge) until you isolate the break.

---

## Missing Workstation

To locate a missing workstation with Inter•Poll:

1. Using your network map, determine the location of the missing device relative to the Inter•Poll workstation.
2. Go to the location of the missing device and:
  - a. Check connectors and cables.
  - b. Make sure the network connection is attached properly (e.g., the LocalTalk connector should be attached to the printer port).
  - c. If you are using System 6, make sure the Responder is inside the computer System Folder. (The Responder is built into System 7.)
  - d. Make sure AppleTalk is set to **Active** in the Chooser window.
3. Repair or replace malfunctioning connectors, cables, or software. Try displaying the missing device again.
4. If you receive no response and if you can't see any network services from the affected workstation's Chooser, the problem may be caused by the device's internal network connection hardware. Substitute a known-good device, and consult your hardware service representative about the malfunctioning equipment.

---

## Symptom/Cure Chart for General Troubleshooting

The following symptom/cure chart pertains to any type of AppleTalk network. If your AppleTalk network displays one of the symptoms in the chart, perform the troubleshooting steps next to that symptom.

For additional symptom/cure charts that are specific to particular types of AppleTalk networks (LocalTalk, EtherTalk, TokenTalk, or Internets), refer to the troubleshooting information in the *Network Types* chapter.

**Note** Each chapter in this manual has additional troubleshooting information that is specific to the hardware or software products presented in that chapter.

<b>Access Problems</b>	<b>Solutions</b>
Can't access a shared device on the network, or a device is missing	<ol style="list-style-type: none"><li>1. Check to see if the device appears in the Chooser.</li><li>2. Check to see if the missing device is switched on and functioning properly.</li><li>3. Check the data path between the user's computer and the missing device to be sure there are no severed cables, broken or damaged connector pins, or disconnected cable extenders or connectors.</li><li>4. If the missing device is a non-Apple printer that doesn't support Name Binding Protocol, you may have to select the printer in some other manner than using the Chooser. Refer to the user manual for the printer.</li></ol>
Users on one end of the network can't access one or more devices that follow them on the network	<ul style="list-style-type: none"><li>– Go to the last device that still appears connected to the network and examine its connector. If there is a break at this connector, the affected device becomes the termination point for that side of the network. Replace the connector, if necessary, and secure the network connection at the break.</li></ul>
User can't access file server	<ul style="list-style-type: none"><li>– See "Server Problems."</li></ul>
User can't access any network services	<ol style="list-style-type: none"><li>1. Check the problem computer's connection to the network. Completely disconnect the computer and reconnect it.</li><li>2. Check the user's Chooser to be sure AppleTalk is activated.</li><li>3. Verify that the user's computer shows up on a device list.</li><li>4. Check the user's Chooser to see if it displays any devices.</li><li>5. Check to see if people on either side of the problem computer are able to access the network. (Problems that appear in one continuous section of the network are likely to be cabling problems.)</li><li>6. Find out if there have been any recent changes to the network, such as new software, devices added or removed, new zones defined, etc.</li></ol>

---

## Server Problems

User can't access file server from the Chooser

## Solutions

1. Monitor user's attempt to access file server to see if problem is result of user error.
2. Check the file server to make sure it is plugged in, switched on, and running. If not, plug in the file server and restart it.
3. Check the network connections at the file server and at the user's computer.
4. Print a device list to be sure the user's computer and the file server appear on the network. If troubleshooting an Internet, make sure routers, bridges, or backbone networks in the path between the user's computer and the file server also appear.
5. Be sure the file server has the appropriate network interface cards. Check to see that the cards are seated securely and configured properly.
6. Check to see that routers, bridges, and backbone networks are operational.
7. See the "File server is down" symptom.

File server is down

1. Verify that the file server is plugged in and running. If not, plug in the server and restart.
2. If error messages are present, refer to the user manual for the file server.
3. Verify that you don't have a hardware problem with the server.
4. Be sure the file server has the appropriate network interface cards and that they are seated securely and configured properly.
5. Check that all network cables and connectors are secure and in good condition.
6. Verify that there are no irregularities in the server's external or internal power source.

File server is experiencing intermittent problems

1. If error messages are present, refer to the user manual for the file server.
2. Be sure that all network cables and connectors are fastened securely and in good condition.
3. Verify that the file server's hard drive is operational. If not, replace the drive.
4. Check for hardware and software configuration conflicts, such as incompatible versions of network interface cards or network software. Make sure you have the same version of AppleShare software on the workstations and file server.
5. Verify that there are no irregularities in the server's external or internal power source.
6. Refer to the "User can't access file server" symptom.

File server doesn't work with Apple IIGS computers

- If the network includes Apple IIGS computers, use the server installer disks to install AppleShare IIGS Workstation software on each AppleShare File Server.

---

**Printer Problems****Solutions**

User can't print

1. If the user can access other network services, such as electronic mail, file server, etc., then:
  - Make sure the printer is on.
  - Make sure the printer is not busy.
  - Check the cabling from the printer to the network.
  - Check to see if the printer appears in the user's Chooser and verify that the printer is selected.
  - Print a device list to see if the printer appears.
2. Reinstall the printer driver software on the workstation.
3. Check the cabling that connects the workstation to the network.
4. Verify that the AppleTalk option is activated.

Delays in printing

1. Make sure that you don't have different versions of printer software on the computers sharing the printer (System 6 only). Different printer driver versions will cause the computers to reinitialize the printer each time they print when you are using System 6.
2. Using a traffic-monitoring program, compare current and previous printer usage. If printing activity has increased significantly, consider adding a printer or print spooler to the network.

Printer busy or buffer overrun message appears

1. Switch the printer off and on.
2. Reinstall the printer driver software on the workstation.

ImageWriter II/LQ printer is not operational

1. Verify that you have an ImageWriter II/LQ LocalTalk Option Card installed and that the dip switches are set correctly.
2. Check the cabling.
3. Replace the ImageWriter II/LQ LocalTalk Option Card with a known-good card.

Third-party printer won't print

1. If the network connection is not built into the printer, make sure you have installed the necessary adapter, intermediary device, or networking software to connect the printer to the network.
2. Check the cabling.

Unsatisfactory print quality when using third-party printer

- Some third-party printers don't support high-resolution Macintosh graphics. Refer to the printer manual.

**E-Mail Problems****Solutions**

Can't send mail to another user on the network

1. Check to see if the mail server(s) is switched on and functioning properly.
2. Use the Chooser to see if the server, the sender computer, and the receiving computer all show up on the network.
3. Check connections from recipient's computer to the network.

- 
4. If working with a LocalTalk network, make sure there are no cables dangling from LocalTalk connector boxes.
  5. Refer to the administrator's guide for the E-mail product.

### **Individual Computer Problems**

Macintosh LC II computer freezes

- #### **Solutions**
1. Upgrade the ROM on the Apple Ethernet LC Card.
  2. Reinstall the network and system software.

Performance degradation on a user's workstation

- If other people in a distributed file sharing environment are accessing the user's workstation, performance on the workstation will decline. Move heavily used shared files to a dedicated file server.

Problems with one workstation

1. Verify that the workstation is running and able to perform non-network tasks.
2. Verify that the workstation software is compatible with the hardware and that the software is configured correctly.
3. Check to see that necessary interface cards are present and properly seated.
4. If the workstation has a network interface card, be sure the card is the correct version and that it is configured properly.
5. Be sure that all other hardware assemblies are configured properly.
6. Check that all network cables and connectors are secure and in good condition.
7. Verify that there are no software application conflicts with other workstations.

Problems running a particular application on a workstation

1. Verify that the application can be used in a network environment.
2. Check to see that the software is properly configured and that there are no hardware or software conflicts.
3. Install a known-good copy of the software.

### **Network Degradation Problems**

General delays on the network

- #### **Solutions**
1. Use a traffic-monitoring tool to check for excessive traffic. If the traffic problem is temporary, ask users to access network services at different times. If the traffic problem is long term, consider the following solutions:
    - Redesign the network to relocate servers, printers, computers, etc.
    - Add a bridge, router, or backbone network.
    - Add additional servers, printers, or other shared devices.
    - Switch to a faster type of network.
    - Restructure the affected networks to balance traffic.

- 
2. Make sure you don't have too many devices on the network, network segment, or ring. If you do, subdivide the network with a bridge or router.
  3. Make sure you don't have system software conflicts. You can verify software version numbers through:
    - The About selection from the Apple menu when working from an application
    - The Get Info selection from the File menu when working from the Finder
    - An administrative tool, such as Inter\*Poll
  4. Make sure all devices on the network have the same printer driver version (System 6 only). An error message usually appears if the user's computer has a different version from the rest of the network. You can use Inter\*Poll to check driver versions.
  5. Verify that your AppleShare workstation software is compatible with your AppleShare file server software.
  6. Make sure you don't have too many services on one heavily used server. Your E-mail program should have a dedicated Macintosh computer.
  7. Make sure there aren't too many routers. No packet should have to travel more than 15 hops. You may need to redesign the network or add a backbone network to reduce the number of hops.
  8. Check for viruses on the computer that is experiencing the slowdown.
  9. Check for cable problems (for example, EMI, damaged or loose connections or a cable that exceeds the maximum recommended length).
  10. Instruct users to launch shared applications from their own computers instead of from the file servers.
  11. Generate a traffic graph summary to see where traffic is heaviest. If network usage has increased uniformly across the network, consider dividing the network into zones and adding a router.

Network experiencing excessive overhead traffic – Check to see if the cause of the problem is:

- Routers updating tables
- E-Mail message alerts
- File server volumes mounted on user desktops

Network experiencing excessive user-generated traffic – Check to see if the cause of the problem is:

- User startups
- Excessive printing
- File server accesses (If so, disable automatic file server mounting and make the user manually log onto the server)
- Receiving/sending mail
- Users accessing remote access devices (for example, shared modems).

---

Problems with high-traffic areas on the network

- Redesign the network so as to minimize the need for users to cross networks and zones to access other users and services.

**Device List Discrepancies**

A device listing doesn't match the network map or a previous device list.

**Solutions**

1. Check the cabling on missing devices.
2. Make sure the missing devices are switched on and functioning properly.

**Misc. Problems**

Ghosting—intermittent appearance and disappearance of network services or devices

**Solutions**

1. Verify that you have not exceeded the maximum number of nodes for your type of network. (Refer to the Network Types chapter.)
2. If there are too many nodes connected to the network or to a particular branch of the network, subdivide the nodes into different zones by using a bridge or router.
3. Be sure that the affected devices are properly terminated. (See the Network Types chapter for more information on termination.)
4. Check network connectors to be sure they are secure. (Old AppleTalk Personal Network connectors don't lock and require retention devices to help secure cable connections.)
5. Check to be sure cable extenders are securely connected. Completely unplug and reconnect the cables to make sure there is firm contact.
6. Check for visible cable damage (for example, pinched or kinked cables). If you can't see the damage, use a voltmeter, continuity checker, or Inter•Poll loopback tests to isolate the problem. If necessary, replace the damaged cable.
7. Verify that you have not exceeded the maximum cable length for your network. If any cable exceeds the recommended length, install a repeater or subdivide the network with a bridge or router.
8. AppleTalk packets can only traverse a maximum of 15 hops. If necessary, redesign the network or install a backbone for more efficient network routing.
9. If you are using System 6, you may have more devices in one zone than the Chooser can display. Upgrade to System 7 or add more zones.

Network experiencing intermittent, hard-to-diagnose problems

1. These problems may be the result of power fluctuations. Install an uninterruptible power supply (UPS) on a constant-voltage transformer (CVT).
2. Verify that there's a common earth ground between all devices. Differences in quality of electrical ground between devices can result in a ground loop—external interference that produces intermittent data transmission errors.



---

EMI problems	<ol style="list-style-type: none"> <li>1. Make sure network cable is not near electrical or mechanical equipment (e.g., elevators, air conditioning, fluorescent lights, radio transmitters, industrial machinery).</li> <li>2. Don't run cable next to power lines unless you separate the two by conduit or a metal shield. Some installations (for example, manufacturing floors) are better suited to fiber-optic networks.</li> </ol>
Excessive transmission errors	<ol style="list-style-type: none"> <li>1. Run a loopback test to see if transmission errors increase at peak hours. If so, you may need to install a bridge or router.</li> <li>2. If transmission errors occur on a LocalTalk bus network, be sure that both ends of the network are properly terminated. (Note: Apple LocalTalk connectors are self-terminating. Third-party products, such as PhoneNET connectors, may not be.)</li> <li>3. Check for cable problems (damaged or loose connections, a cable that exceeds the maximum length, EMI, etc.).</li> </ol>
Timeout, overrun, CRC, or length errors—packets arrive damaged	<ol style="list-style-type: none"> <li>1. Check for cable problems (damaged or loose connections, a cable that exceeds the maximum length, EMI, etc.).</li> <li>2. Check for excessive traffic on the network. (Refer to the symptoms in the chart that deal with excessive traffic problems.)</li> <li>3. Check to see if you have a software or hardware problem with the sending device.</li> </ol>
High number of cyclic redundancy check (CRC) errors uncovered during traffic monitoring	<ul style="list-style-type: none"> <li>– See the "Ghosting—intermittent appearance and disappearance of network services or devices" symptom.</li> </ul>



We welcome your comments on the *Networking and Communications Service Guide*. Please use the AppleLink<sup>®</sup> address below to send us your comments and suggestions:

**AppleLink: ASG**

The *Networking and Communications Service Guide* is a product of the Apple Service Technical Publications Group.

**Lead Writer:** Cookie Smith

**Writer:** Kathy Smith

**Graphic Artist:** Steve Rancourt

**Editors:** Kay Tierney, Hunter Greer

**Production:** Cherie Martin

This Apple manual was composed on a desktop publishing system using Apple Macintosh computers. The application software was Aldus<sup>®</sup> FreeHand<sup>™</sup>, QuarkXPress<sup>®</sup>, Tycho Table Maker<sup>™</sup>, and Microsoft<sup>®</sup> Word. Apple LaserWriter<sup>®</sup> II printers produced proof pages.

Apple Computer, Inc.  
20525 Mariani Avenue  
Cupertino, CA 95014  
TLX 171-576

Printed in the U.S.A.  
072-0393